

CONVERSION OF A DIESEL ENGINE BUS INTO A TROLLEYBUS

This handbook has been prepared by the authors in the framework of the **TROLLEY Project**



The TROLLEY project is implemented through the CENTRAL EUROPE Programme co - financed by the ERDF (www.central2013.eu<<http://www.central2013.eu>>).

GMINA MIASTA GDYNI

81-382 Gdynia, ul Piłsudskiego 52/54

tel. +48 58 66 88 000

<http://www.gdynia.pl>



Authors

Mikołaj Bartłomiejczyk (Przedsiębiorstwo Komunikacji Trolejbusowej Sp. z o.o. w Gdyni),

Jarosław Dombrowski (Przedsiębiorstwo Komunikacji Trolejbusowej Sp. z o.o. w Gdyni),

Marcin Połom (Przedsiębiorstwo Komunikacji Trolejbusowej Sp. z o.o. w Gdyni),

Olgierd Wyszomirski (Katedra Rynku Transportowego, Uniwersytet Gdański)

Any liability for the content of this publication lies with the authors.

The European Commission is not responsible for any use that may be made
of the information contained herein.

Trolleybus pictures designer

Maciej Beister

Reviewer

Dariusz Karkosiński

© Copyright by Gmina Miasta Gdyni, 2012

ISBN 978-83-7531-176-1

Zakład Poligrafii Fundacji Rozwoju Uniwersytetu Gdańskiego

ul. Armii Krajowej 119/121, 81-824 Sopot

Tel. (58) 523 14 49, 523 13 75

e-mail: poligraf@gnu.univ.gda.pl

This handbook has been prepared by the authors
in the framework of the TROLLEY project.
The TROLLEY project is implemented through
the CENTRAL EUROPE Programme co financed by the ERDF
(www.central2013.eu<<http://www.central2013.eu>>).

Municipality of Gdynia – Partner of TROLLEY Project
has received the runner-up award in the CIVITAS AWARDS 2012
in the Technical Innovation Category for elaborating the handbook
“Conversion of old diesel engine buses into trolleybuses”

CONTENTS

INTRODUCTION	7
1. THE IDEA OF BUILDING TROLLEYBUSES IN ONE'S OWN WORKSHOPS – PROJECT PHASE	9
1.1. Choosing the coachwork (of a diesel engine bus)	9
1.2. Available drive solutions – choosing the type of drive	9
1.3. Documentation preparation phase	10
1.4. Preparation of the tight schedule of the investment	12
2. PROCESS OF FORMAL PREPARATION FOR CONVERSION	16
2.1. Administrative and technical requirements for the conversion of diesel engine buses into trolleybuses	16
2.2. Specification of arrangements and expert opinions	24
2.3. Examples of the varying requirements in the scope of trolleybus communication in European countries	24
3. PHASE OF CONVERTING A DIESEL ENGINE BUS INTO A TROLLEYBUS	25
3.1. Bus dismantling phase	25
3.2. Preparing the coachwork for building with an electric drive – endurance tests	25
3.3. Building a coachwork with an electric drive	26
3.3.1. Contactor drive – trolleybus MB O405NE	26
3.3.2. Chopper drive – trolleybuses MB O405NI	32
3.3.3. Asynchronous drive – trolleybus MB O405NAC	33
3.3.4. Asynchronous drive – trolleybus MB O530 Tr12/TV.EU	37
3.3.5. Asynchronous drive – trolleybus MB O530AC	38
3.4. Setting the trolleybus in motion, phase of stationary and movement tests ..	39
4. PROCESS OF TROLLEYBUS REGISTRATION	41
4.1. Trolleybus official certification tests conducted by authorised institutions .	41
4.2. Registration of a trolleybus as a vehicle with an electric drive	44

5. EXPLOITATION EXPERIMENTS	45
5.1. Exploitation experiments in Gdynia	45
5.1.1. Failure frequency of electric drive elements	46
5.1.2. Failure frequency of mechanical elements	47
5.2. Exploitation experiments in Szeged	55
5.3. Analysis of the strong and weak points of conversion	57
6. ECONOMIC EVALUATION OF THE PROCESS OF CONVERSION BUSES INTO TROLLEYBUSES BY PKT IN THE YEARS 2004–2010	58
6.1. The background of economic evaluation	58
6.2. Initial value of the converted and newly manufactured vehicles	58
6.3. Duration of the conversion of the vehicles	62
6.4. The relation of the initial value of the converted and brand new vehicles as a criterion for the economic evaluation of the process	62
6.5. Conclusions on economic evaluation	64
SUMMARY	66
BIBLIOGRAPHY	68
LIST OF TABLES	69
LIST OF FIGURES	69
SUPPLEMENT	71

A vertical grey bar is positioned to the left of the section header.

INTRODUCTION

The major factor shaping the costs of functioning of environmentally friendly public transport powered by electricity are rolling stock prices, apart from the necessary infrastructure and supply system of the overhead traction. The prices of new trolleybuses are significant. The European market of low floor trolleybuses is very hermetic and limited. As a consequence, we may observe quite high prices of trolleybuses as compared to buses with diesel engines or those powered by alternative fuels.

Trolleybus Company LLC in Gdynia (PKT) also faced the problem of reconstructing rolling stock fleet by buying new expensive low floor vehicles. In 2003 the disproportion between the quality of bus and trolleybus transportation in Gdynia was significant. Bus companies had mainly low floor buses, whereas PKT possessed only 7 low floor vehicles for about 65 trolleybuses running on weekdays. The rolling stock fleet consisted mainly of the overexploited high floor trolleybuses PR110E and 120MTE made by Jelcz.

The concept of building trolleybuses based on the coachwork of low floor buses coming from the aftermarket, which was, in fact, the conversion of buses into trolleybuses, appeared in Gdynia for the first time in 2003. There was a shortage of modern trolleybuses tailored to the needs of disabled people and providing a good level of comfort for other passengers. At the same time, Trolleybus Company LLC., being a trolleybus operator, was not able to reconstruct its rolling stock to a sufficient degree. According to the cyclical marketing research concerning transportation preferences and behaviour conducted every two years by The Public Transport Board in Gdynia, the local transport organizer, trolleybus services were less popular among citizens because of the lower standard of the vehicles. As a result of this was stated the concept of the conversion of buses into trolleybuses. The concept was created by sympathizers of trolleybus transportation, the Public Transport Board in Gdynia and Trolleybus Company LLC. On the basis of knowledge, technology and exploitation experience, it was decided that there would be an attempt to build two prototype low floor trolleybuses by converting buses and providing them with electric equipment coming from old Jelcz buses that were no longer in use. After preliminary

calculations it was assumed that buying an approximately ten-year-old vehicle on the aftermarket, modernizing the electric equipment and carrying out the necessary readjustment would cost as much as the main repair of a 15 years old low floor trolleybus. The conception guaranteed the low cost of acquiring a low floor trolleybus (26–37% of a brand new vehicle). Considering that Trolleybus Company LLC was financially viable to renovate about 5–6 trolleybuses a year, a rapid increase in the number of trolleybuses provided by conversion was achieved.

1 | **The idea of building trolleybuses in one's own workshops – project phase**

1.1. Choosing the coachwork (of a diesel engine bus)

On the basis of knowledge already possessed by the transportation organizer and based on the exploitation of many types of low floor vehicles by different bus operator, Trolleybus Company LLC in Gdynia. decided to select for conversion the coachwork of a Mercedes Benz O405N, a 12-metre-long vehicle available on the aftermarket together with spare parts. Interestingly, this would have been the first Mercedes (O405N) vehicle of this type exploited in the world.

The of Public Transport Board in Gdynia (pol. ZKM) set the technical requirements for the converted vehicles. The trolleybuses were to possess three doors, at least four hopper windows and a stepless floor throughout the bus. As these Mercedes met such requirements, preparations for work on the first vehicle began.

In the first instance, a legal technicality concerning the registration of the vehicle proved to be a problem. After solving this issue and obtaining acceptance of solution offered, the process of purchasing the bus began. „The donor“ of the coachwork for the first trolleybus was a Mercedes Benz from 1993 from Erfurt. Its rolling stock number was 128. One of the project's postulates was that a bus coachwork used for conversion into a trolleybus should not be older than 10 years. In September 2004 the contractor provided the coachwork and Trolleybus Company Gdynia LLC. began the adjustment works.

1.2. Available drive solutions- choosing of the type of drive

Whilst finalizing the project of converting buses with diesel engines into trolleybuses, it was discussed whether the drives installed in the converted coachwork should come from brand new or written off trolleybuses. The drives already possessed by the carrier were quite obsolete and there was no possibility to save energy due to the lack of regenerative braking. However, the repair

cost of traction drive elements coming from older type trolleybuses was disproportionate to the cost of buying a new impulse (constant current) or asynchronous drive. Planning the low costs of conversion, it was decided to use repaired elements of contactor drives coming from Jelcz trolleybuses and to use a new, in-house designed drive controller. In the later phase of development of the concept of converting buses into trolleybuses Trolleybus Company LLC in Gdynia was financially able to apply more modern drives. Table 1 presents the number of Mercedes buses equipped with different kinds of drives.

Table 1. Number of converted trolleybuses operated by PKT according to their type of drive

Type	Type of drive	Number of trolleybuses	Years of production
Mercedes O405N2E	Constant current drive, contactor drive	22	2003–2009
Mercedes O405N2I	Constant current drive, impulse drive	1	2008
Mercedes O405N2AC	Asynchronous drive	5	2010

Source: *Own work.*

1.3. Documentation preparation phase

The conversion of a bus into a trolleybus which meets the appropriate standard requires complete adherence to technical guidelines. The main principles of governing conversion of a bus into a trolleybus, including the preparation of documentation, are:

- all significant decisions should be based on experts' opinions (preferably highly educated and well known in public transport industry) in the fields of: electro technology and electronics; mechanics; vehicles; marketing and organisation of public communication; economics. Opinions of people operating vehicles (drivers and technical workers) and passengers should also been taken into consideration; however, those opinions should not be predominant. The initial assumptions should be consulted with institutions allowing trolleybuses to transport passengers.
- the type of bus selected for conversion should be clearly specified. Before making the final decision, the suitability of a particular type of bus selected for conversion into a trolleybus should be thoroughly verified.
- it must be decided what equipment (drive and auxiliary systems) will be installed and where (i.e. inside, on the roof).

- before starting the conversion one should thoroughly analyse the functioning and check the efficiency of the complete vehicle selected for conversion.
- study thoroughly the technical (especially electrical) documentation, checking if it is consistent with the actual state of the vehicle.
- purchase the bus for conversion.
- create the exact specification of equipment typical of trolleybuses, considering all significant conditions of building in coachwork as well as its technical and economical performance. Order the equipment typical of trolleybuses. If possible, complete the specification of the checked drive, accepting the deeper interference in the available coachwork; however, it should not be done at any price.
- study thoroughly the documentation of the equipment typical of trolleybuses. Technical requirements of correct functioning should be analysed again.
- execute a project of conversion that is as detailed as possible and takes into consideration both the electrical and mechanical parts of the vehicle. It is important to apply the aforementioned technical guidelines, provide the proper tools (e.g. CAD software, telephone, Internet, etc.) and ensure that the required data (technical documentation of the bus and its equipment) and working conditions (both generally as well as the required time and a peaceful environment) available to the designers. One should employ the constructors (electrical engineers with experience of electrical traction, especially trolleybus traction) and mechanics familiar with the common issues of the vehicle.
- the completed project should enable work to be carried out on its basis by individual physical workers with emphasis on their professional preparation and discipline.
- tasks and responsibility should be clearly and specifically divided among the workers involved. Oblique statements are the potential reason for lowering quality, faults and conflicts. Possible changes of responsibility and tasks for individual workers and groups of workers should be official.
- a designated person should be in charge of finalizing work according to the project and providing the documentation for possible departures agreed with constructors; the departures should be considered in the subcontract documentation.
- after finishing the conversion one should issue detailed technical documentation in two versions. A service version should be generally available for technical (depot) workers in an electronic version prepared for printing. A full version is required for the full documentation of the conversion, which can assist in solving problems that emerged during exploitation and

form the basis for the modification of the purpose of another similar conversion.

- all later changes should be documented in detail (full description) and marked in the documentation.

As mentioned above, without preparing technical documentation one cannot professionally convert a bus into a trolleybus. Considering the conditions prevailing in transport companies, it is difficult to fulfil all aforementioned basic principles of technical culture, including preparing documentation, in converting a bus into a trolleybus. We can also observe the lack of awareness (or even hostility), means and time for professional conversion; therefore, the effect is often a converted trolleybus with structural defects which is different from other trolleybuses of the same type but with the same equipment, which obviously has an influence on failure frequency. The lack of technical documentation often causes problems with repairs.

1.4. Preparation of the tight schedule of the investment

Each major investment requires a schedule which specifies the time limits and order of execution of physical, formal and project works. The schedule can be divided into individual stages and threads. Some work can be performed simultaneously and others in turn after fulfilling some specified conditions. The Figure 1 presents a sample schedule of conversion. The aforementioned flexible schedule concerns only the technical sphere of the conversion. The work was divided into four threads; however, there are stages when more than one thread has to be completed. The flexible schedule considers working days actually assigned for conversion with the required number of workers of a particular profession and percentage workload (fulfilment of working time rate) in a particular task. As can be observed, the majority of problems typically associated with depots and delaying the completion of work have no influence on meeting the schedule. Moreover, while writing this chapter the aforementioned schedule has not been practically verified or even begun, because the conditions required for the first stage to commence have not been fulfilled. The conclusion is that this schedule should be regarded like a project rather than a recipe.

In the past more rigid schedules were used. They included specified dates and did not consider such issues as undertaking the work in depot conditions, problems with supply, the necessity to engage the workforce in tackling current problems and other unexpected issues, which occurred almost on regular basis. A rigid schedule has always become a document impossible to fulfil in reality;

it only served to spoil the cooperation between workers and prevented the development of new concepts. The final summaries suggested that the workload in other analogous conversions was comparable, regardless of the time limit (interweaving with other work).

In conclusion, while writing the investment schedule, one must take into consideration that problems with its completion may occur. Nevertheless, the schedule is definitely useful for independent departments, companies and in a case of commissioning the conversion to an external operator.

Schedule of conversion of the first bus CITARO into a trolleybus. Date of starting conversion:		Gdynia 18.03.2011					
Weekday of conversion	WORK THREADS (TASKS to perform, REQUIREMENTS necessary to complete the task; PERCENTAGE of workers' engagement time), number, occupation;				COMMENTS		
1	TASK: Analysing coachwork construction as well as the supplied technical documentation;						
2	REQUIREMENTS: Supplied technical documentation of the coachwork; supplied coachwork;						
3	WORKERS: 3 electricians; 2 mechanics; 2 tinmen; 2 office workers						
4	TASK:						
5	Checking, launching and adjusting remaining bus systems; making technical arrangements on the distribution of the appliances and applied solutions. REQUIREMENTS: Supplied technical documentation of the coachwork and equipment; WORKERS: 70% 3 electricians; 50% 2 mechanics; 30% 2 tinmen; 60% 2 office workers.	TASK: Preparing the technical documentation allowing for commencing the work; REQUIREMENTS: Supplied technical documentation of the coachwork and equipment; running CAD software WORKERS: 10% 2 electricians; 10% 2 mechanics; 10% 2 tinmen; 70% 1 office worker.	TASK: Regeneration of current collectors bases; preparing the seal wires of electrical wires REQUIREMENTS: Availability of materials and parts WORKERS: 50% 1 tinman.	TASK: Internal directive to construct a set of sonic and light indicators; fan programmer; system of adjusting the velocity signal; adjusting the driver's control desk; Preparing turned elements (insulator shades), brazen pads for the automotive batteries disconnectors, insulators of current collectors bases, insulators of traction engine, insulated clutch, booster pump clutch. REQUIREMENTS: Supply of electronic parts and materials for turning. Launched CAD software WORKERS: 80% 1 electrician; 20% 1 tinman; 50% 1 turner; 50% 1 mechanic; 10% 1 office worker.			
6							
7							
8							
9							
10							
11	TASK:		TASK:				
12	Dismantling vehicle's lighting, buttons, driver's control desk and other indicated elements of electrical equipment. Regeneration of some aforementioned elements REQUIREMENTS: Recommending the storage place WORKERS: 70% 3 electricians.		Dismantling passenger seats, lateral flaps, ceiling plates and other indicated elements of internal equipment. REQUIREMENTS: Recommending the storage place WORKERS: 80% 2 tinmen; 80% 1 upholster.				
13							
14							
15							
16	TASK: The visit of representatives from ENIKA company and approving the idea of conversion. REQUIREMENTS: Complete documentation WORKERS: 10% 3 electricians; 10 % 2 mechanics; 10% 2 tinmen; 70% 2 office workers.						

17	TASK: Visit of an expert concerning the alteration in a coachwork and approving the idea of conversion. REQUIREMENTS: Complete documentation WORKERS: 50% 2 office workers;			
18		TASK: Current setting the course of the work; preparing technical documentation allowing for continuation of work; documenting completed works. REQUIREMENTS: Supplied technical documentation of the coachwork and equipment; running CAD software WORKERS: 10% 2 electricians; 10% 2 mechanics; 10% 2 tinmen; 70% 1 office worker.	TASK: Adjusting the coachwork to installing the equipment; testing traction engine welds REQUIREMENTS: Availability of parts and materials; documentation. WORKERS: 80% 2 tinmen; 80% 1 upholster; 60% 2 mechanics.	
19				
20				
21				
22	TASK: Preparing electrical boards, subassemblies and junctions REQUIREMENTS: Availability of parts and materials; documentation WORKERS: 70% 3 electricians.			
23				
24				
25				
26				
27				
28				
29				
30				
31	TASK: Outside varnishing of a vehicle REQUIREMENTS: Material availability; fixed pattern of painting. WORKERS: 90 % 2 varnishers; others: making up for possible delays			
32				
33				
34				
35				
36		TASK: Current setting the course of the work; preparing technical documentation allowing for continuation of work; documenting completed works. REQUIREMENTS: Supplied technical documentation of the coachwork and equipment; running CAD software WORKERS: 10% 2 electricians; 10% 2 mechanics; 10% 2 tinmen; 40% 1 office worker.	TASK: Installing the equipment REQUIREMENTS: Availability of parts and materials; documentation WORKERS: 80% 2 tinmen; 80% 1 upholster; 60% 2 mechanics.	TASK: Installing and launching SIP and monitoring REQUIREMENTS: Availability of parts and materials; settled auctions; documentation WORKERS: EXTERNAL COMPANY 10% 1 tinman; 20% 2 electricians.
37				
38				
39	TASK Installing electrical equipment REQUIREMENTS: Availability of parts and materials; documentation WORKERS: 70% 3 electricians.			
40				
41				
42				
43				
44				
45				
46				
47				
48	TASK: The visit of representatives from ENIKA company together with launching the equipment; tests in the area of depot REQUIREMENTS: Complete documentation WORKERS: 10% 3 electricians; 10 % 2 mechanics; 10% 2 tinmen; 40% 2 office workers.			
49				
50				
51				
52				
53				
54				
55				

56	TASK:	
57	Visit of the representatives of ENIKA company together with technical tests (EMC; insulation); tests on diagnostic station. Introducing the vehicle to service. Official formalities	
58		
59	REQUIREMENTS: Complete documentation	
60	WORKERS: 40% 3 electricians; 10 % 2 mechanics; 10% 2 tinmen; 70% 2 office workers.	
61	TASK:	
62	Technical tests and introducing the vehicle to exploitation. Removing imperfections and making allowances	
63	REQUIREMENTS:	
64	Complete documentation	
65	WORKERS: 30% 3 electricians; 10 % 2 mechanics; 10% 2 tinmen; 60% 2 office workers.	

Fig. 1. An example of the schedule of conversion of a bus into a trolleybus

2

PROCESS OF FORMAL PREPARATION FOR CONVERSION

2.1. Administrative and technical requirements of converting diesel engine buses into trolleybuses

At the beginning of completing the conversion of buses into trolleybuses, the basic act normalizing technical requirements for Polish trolleybuses to meet was Minister of Infrastructure Regulation on 22nd December 2003 of technical conditions of buses and trolleybuses as well as their necessary equipment (Dziennik Ustaw official gazette poz. 2301 on 31st December 2003). The following parameters for trolleybuses were defined:

- 1) the noise level with auxiliary engine working, measured at the distance of 3,0 meters from the bus and at the height of 1.6 m cannot be higher than 70 dB at any place;
- 2) the floor and the steps should be covered with dielectric material;
- 3) railing and handles should be covered with dielectric material or insulated from the coachwork;
- 4) electrical installation should have the insulation ensuring that the leakage current in conditions of the greatest humidity does not exceed 0.7 mA;
- 5) the resistance of the main circuit insulation (galvanically integrated) in conditions of the greatest humidity must not be lower than 1.3 M Ω ;
- 6) the insulation of the main circuit while the electric machines are detached should withstand the applied voltage 4.5 kV and the frequency of 50 Hz during the period that must not be shorter than 60 sec.;
- 7) the resistance of control circuit insulation in conditions of the greatest humidity must not be lower than 0.5 M Ω ;
- 8) electrical installation of the main circuit should have two-stage insulation;
- 9) current collectors should ensure the freedom of trolleybus movement in the area of around 4.5 m from the contact system;
- 10) the pressure force of current collectors to contact system in the range of their work should remain within the limits of 100–140 N;

- 11) an electrodynamic working brake should ensure the stop of an unladen vehicle on the dry, hard and horizontal surface with the velocity of 30 km/h after 24.8 m, which equals the deceleration of 1,4 m/s².

In 2011 new, more restricted and precise technical requirements for trolleybuses were introduced. (Dziennik Ustaw official gazette nr 65, Minister of Infrastructure Regulation on 2nd March 2011):

General requirements:

Subject to the provisions of section III, the rules on technical conditions of vehicles and their range of equipment are respectively applied to trolleybuses, on the condition that:

- 1) the noise A level outside the vehicle, during its stop with auxiliary engines working at a distance of 6 m from the wall of trolleybus coachwork at a height of 1.2 m ± 0.2 m must not exceed 64 dB; however, in trolleybuses equipped with an autonomous driving system with a combustion engine the noise level can reach 80 dB;
- 2) the first step of entrance door should be covered with dielectric material; in a low floor trolleybus it also concerns the floor area near the entrance door. Its width should be at least as wide as the door opening and its length should be at least 800 mm long from the entrance into the bus. In addition, the resistance of the dielectric material measured in term of trolleybus ground should be at least 2 MΩ for the measurement conducted in dry conditions with a probe with a contact surface of 300 cm² ± 5 cm²;
- 3) the entrance door railing and all handles are within the reach of a passenger standing on the floor near the edge of entrance step must be made of dielectric material or isolated from the floor of the trolleybus. In addition, the resistance of insulation of railing and handles measured in terms of coachwork should be at least 2 MΩ. The measurement should be conducted with a point probe in the case of railing made of conductive material or a surface probe with contact surface of 50 cm² ± 5 cm² in the case of railing made of dielectric material;
- 4) the assist system of steering mechanism should function for at least 10 sec. at a velocity over 5 km/h in case of power outage in the contact system.

Electrical installation

1. Trolleybus can be fed from the contact system of a voltage rating of 600 or 750 V.

2. Electrical and electronic appliances should not emit excessive electromagnetic disturbances which are radiated to the environment.
3. Electrical installation should be constructed and maintained in the following way:
 - live elements cannot be accessible to passengers and those outside of the vehicle;
 - the installation should be protected against mechanical damage, corrosion and flooding;
 - installation of low voltage should be provided with a switch within easy reach of the driver enabling the battery to be disconnected from the installation without using any tools;
 - the installation fed directly with power voltage should be provided with switches turned on and off from the driver's position without using tools and enabling the disconnection of the installation from the current collecting circuit;
 - the insulation resistance of the installation fed with power voltage and galvanically integrated, measured with a gauge with a test voltage 1000V in terms of trolleybus ground should be at least 1.3 MΩ, and for a trolleybus awaiting introduction into service it should be at least 6 MΩ;
 - circuits fed with power voltage, auxiliary and control circuits as well as the circuit of an autonomous driving system (if such a system occurs) should have overload protection enabling the electrical to be stopped in a case of short circuit or over current;
 - circuits fed with power voltage should function correctly with any polarity of contact system voltage; however, it is permitted that if regenerative braking occurs, it is realized only in one agreed polarity of contact system;
 - a trolleybus adapted to return energy to the contact system should meet the requirements concerning the acceptable levels of voltages defined in the standard mentioned in point 3 of enclosure no. 1 of the regulation;
 - to enable it to drive through the car wash with the supply voltage within the limit of 60 – 80 V;
 - in a multiple trolleybus the appropriate cables enabling mass connection among individual parts of the coachwork should be installed;
 - all exposed elements made of conductive materials and available to passengers and outsiders on the stipulation of § 19 pt 3 should have the same potential as the earth of the trolleybus's coachwork. It does

- not apply to conductive elements properly separated from any active conductive elements causing the risk of electric shock;
- a power outage in the current collecting circuit or in the power source of the trolleybus's autonomous driving system should be alerted to the driver by a proper acoustic signal;
 - when the current collectors are not connected to the contact system, the voltage on the electrical installation elements with IP2X protection degree cannot exceed 60 V (Dziennik Ustaw official gazette Nr 65 – 4131 – Poz. 344);
 - the traction drive control system should prevent driving when the entrance doors for trolleybus passengers remain open or do not close properly; 15) the voltage of direct current control installation should not exceed 60 V, and the voltage rating of three phase auxiliary installation should not exceed the wire value of 400V.
4. Electrical appliances powered by power voltage should have two stage insulation in terms of the vehicle's ground:
- the first insulation stage of new appliances powered by voltage power after installing them in a trolleybus should resist the test with an alternative voltage of root-mean-square value $2.5 U + 1500$ V and a frequency of 50 Hz applied in 60 sec. and performed before introducing the vehicle into exploitation, where U is the nominal value of the contact system voltage expressed in volts; however, the requirements for electrical traction machines of direct current concerning the resistance of dielectrical insulation of these machines are expressed in a standard mentioned in point 2 of Annex 1 of the Regulation (the disconnection of electrical traction machines whilst testing the electrical equipment after its installation in a trolleybus is permitted only if the dielectrical insulation withstanding tests have previously been performed);
 - the second stage of insulation of new appliances powered by power voltage after installing them in a trolleybus should resist the test with alternative voltage of root-mean-square value 2300 V and frequency 50 Hz applied in 60 sec. and performed before the introduction of the vehicle into exploitation;
 - the two stage insulation of new current collectors and all other new appliances installed before power switches mentioned in paragraph 3 of point 4 should resist the test with alternative voltage of root-mean-square value $3.5 U + 1900$ V and frequency 50 Hz applied in 60 sec. between collectors current circuit where U is a nominal value of contact system voltage expressed in volts; the test is performed after installing

- trolleybus equipment with open switches mentioned in paragraph 3 point 4;
- in case of regenerated elements of electrical installation, the resistance of the insulation of those elements should be tested for 60 sec. with an alternative voltage of frequency 50 Hz and the root-mean-square value reduced to 80% of respective values of testing voltages accepted for new trolleybus appliances;
 - each insulation stage should have insulation resistance of at least 1.5 M Ω , and a trolleybus awaiting introduction into exploitation should have at least 6 M Ω ;
 - subject to paragraph 6, the use of so called reinforced insulation as equivalent to two stage insulation is permitted, as long as its voltage resistance is verified by the voltage test with the parameters of testing voltage mentioned in point 3;
 - three stage auxiliary installation should meet the following requirements:
 - the voltage resistance of this installation in terms of trolleybus weight should equal the voltage resistance mentioned in point 2; however, for trolleybuses produced before 1st June 2011 the use of three stage auxiliary appliances with dielectrical resistance verified by alternative voltage test with the root-mean-square value reduced to 1800 V is permitted;
 - the insulation resistance of network circuit should be verified by the
 - the insulation resistance of this installation measured in terms of trolleybus ground and network circuits should not be less than the value mentioned in point 5;
 - in case the steering installation of appliances powered by power voltage does not have two stage insulation in terms of network installation, it should be insulated from the floor of the trolleybus; the strength and resistance of this installation insulation in terms of trolleybus ground and network installation should comply with the requirements mentioned in point 7.
5. A trolleybus equipped with an autonomous driving system should meet the following requirements:
- the switching off of this system should be only feasible with disable switches mentioned in paragraph 3 point 4;
 - an installation comprising of an autonomous energy source can have one stage insulation when it comes to the trolleybus earth meeting the requirements in terms of strength and resistance mentioned in para-

- graph 4 points 2 and 5, provided that it is galvanically separated from the network installation whilst driving using power from contact system; the parameters of this separation in terms of strength and resistance of this insulation should meet requirements mentioned in paragraph 4 point 1 and 5;
- whilst driving using the power from contact system traction accumulators should be charged through a converter providing galvanic separation of the battery circuit from trolleybus network circuit, where the voltage strength and insulation resistance of the separation should meet the requirements mentioned in paragraph 4 point 1 and 5;
 - the room where the automotive batteries are installed should be separated from passenger compartment as well as the driver's position and ventilated with air taken from outside the trolleybus; (Dziennik Ustaw official gazette Nr 65 – 4132 – Poz. 344);
 - the autonomous energy dispenser should be equipped with switches disconnecting it in a galvanic way from the trolleybus's electrical installation, where disconnecting the dispenser should happen automatically after switching off the low voltage electrical installation mentioned in paragraph 3 point 3.
6. The reinforced insulation mentioned in paragraph 4 point 6 cannot be treated as equivalent to two stage insulation with respect to the following appliances powered by power voltage: traction and auxiliary engines, starting and braking resistors, current collectors and lightning protector. In the case of a trolleybus introduced into exploitation for the first time, after 30th June 2011 using reinforced insulation in circuits powered by power voltage is allowed only for wires that meet the requirements concerning the strength of reinforced insulation mentioned in paragraph 4 point 6.
7. Current collectors should be constructed in such a way that:
- they ensure the freedom of trolleybus movement in an area of around 4.5 m from the contact system axis; the static pressure force of current collectors to the contact system at a working height limit of 4-6 m of contact system suspension above the road surface is within the range 80-140 N;
 - they were protected to prevent them falling unintentionally below the roof's level;
 - the automatic pole retriever system works immediately should the current collector lose contact with the contact system; during pole retriever's work the current collector should not hit the vehicle's roof or other accessories installed on the roof;

- it would be possible to pull them off manually with appropriate ropes equipped with a suitable reeling mechanism;
 - the ropes mentioned in point 5 should have tensile strength to force a of at least 10 kN;
 - in the case of rods made of conductive material, the pole rope is electrically insulated from the rod.
8. A trolleybus should be additionally equipped with an appliance enabling the detection of the emergence of dangerous coachwork potential relative to the road's surface; where:
- proper visual and acoustic alerts should inform the driver in a case where the dangerous coachwork potential relative to the road's surface exceeds the level of + 60 V or is lower than the level of – 60 V;
 - when the coachwork potential relative to the road's surface goes beyond the range mentioned in point 1 and at the same time one entrance door remains open; it is required that the switch be disconnected, as was mentioned in paragraph 3 point 4, or the current collectors be lowered.

Brakes

1. A trolleybus should be equipped with the following kinds of brakes:
- working electrodynamic brake using the braking force of a traction engine, acting on wheels of a driving axle – used for reducing vehicle speed, enabling:
 - regulation of the braking intensity;
 - braking from the driving position without using one's hands; working electrodynamic brake should have the acting priority in relation to starting, it should be started with the same pedal as the working mechanical brake mentioned in point 2 in the first phase of pedal movement;
 - a working mechanical brake acting on all vehicle's wheels - used for reducing vehicle speed and stopping it in a quick, effective and reliable way, regardless of its velocity and load as well as the road elevation or decline angle, enabling:
 - regulation of the braking intensity;
 - braking from driving position without using one's hands;
 - emergency brake acting on wheels of at least one axis – used for stopping a trolleybus in case of working brake failure, enabling:
 - regulation of the braking intensity;

- braking from the driving position enabling the driver to hold the steering wheel with at least one hand;
- parking brake – used for immobilisation on an elevation or a decline in the road, enabling:
 - functioning while the driver is absent; working parts of the brake should remain in the braking position only with the help of a mechanical appliance;
 - braking from the driving position; the parking brake is not required if the emergency brake mentioned in point 3 meets the requirements specified in this point.
- 2. Brakes should maintain their efficiency in all exploitation conditions.
- 3. Brakes should also meet the following conditions:
 - the simultaneous activation of the working and emergency brake cannot influence negatively the functioning of the either of them, both when two brakes are efficient and in the case of one brake's damage (Dziennik Ustaw official gazette Nr 65 – 4133 – Poz. 344);
 - brake wear should be easily compensated by the system of manual or self – regulation; the elements of the braking system should have such a movement margin that after heating the brakes or achieving a certain degree of lining wear it is possible to brake without the necessity of immediate regulation;
 - in the case of a brake worked with the energy from a container, if braking with demanded efficiency is not possible without using the accumulated energy, the vehicle should be equipped with (regardless of a manometer) an appliance sending light or acoustic signals warning that the energy reserve has depleted to a level equal to or lower than 65% of its normal level;
 - the functioning of the working electrodynamic brake whilst pressing the starting and braking pedals simultaneously should give priority to:
 - continuing to maintain the vehicle stationary,
 - starting to brake if the vehicle is in motion.
 - a working electrodynamic brake should ensure an average delay of braking of an unloaded bus from the velocity of 30 kph to 5 kph on the vertical road with a hard even and dry surface of not less than 1.4 m/s², and for a trolleybus with a classical commutated direct-current motor of not less than 0.8 m/s².

2.2. Specification of arrangements and expert opinions

In order to register a bus intended for a trolleybus, one should:

- buy a bus;
- reregister the bus (still as a bus) for a new owner;
- convert the bus into a trolleybus;
- obtain a positive expert opinion;
- obtain temporary admittance to service for the duration of the test period;
- obtain positive test results at a vehicle inspection station;
- register the converted vehicle as a trolleybus;
- obtain a positive result of extended tests;

2.3. Examples of the varying requirements in the scope of trolleybus communication in European countries

The main factor influencing the formal legal conditions for the functioning of trolleybus vehicles are regulations connected with the recognition of trolleybus communication as a proper form of transport. In Poland trolleybuses are treated in the same way as in France, Germany or Sweden as road vehicles and are registered in a way similar to buses. In many Central Europe countries trolleybuses are treated as trams and other electrical rail vehicles. Registration and technical tests are performed by railway institutions. In such countries as the Czech Republic or Hungary trolleybuses do not have licence plates, which is also significant in terms of drivers training and qualifications. In the past Polish trolleybus drivers were not required to be qualified to drive buses (driving licence D category); nowadays this is essential.

In technical terms trolleybuses are treated in Poland equally to buses as far as their coachwork is concerned; however, in terms of electrical tests, the ministerial regulations are the basis of demands. Certifying and later technical tests are the tasks of The Institute of Physical Planning and Housing from Warsaw.

3 Phase of converting a diesel engine bus into a trolleybus

3.1. Bus dismantling phase

Before commencing the conversion it is necessary to remove the unnecessary equipment, which will not be useful in the process of conversion. The dismantling is the first phase of conversion.

The following elements are removed:

- a combustion engine together with cooling system,
- a gearbox,
- an engine connected with the compressor and a hydraulic pump,
- fuel tank (only in vehicles Mercedes O530).

Having finished dismantling, the rear engine space is released, which enables further adaptation of this space for electrical machinery. The operations performed are relatively easy and therefore, the dismantling stage is short lasting about a week.

3.2. Preparing the coachwork for building with an electric drive – endurance tests

Conversion of a bus into a trolleybus requires building the roof with the following elements of electrical machinery:

- current collectors,
- starting and braking resistors,
- lightning protector,
- static converter (in the case of trolleybuses with power electronic machinery),
- traction inverter (in the case of Mercedes O530 vehicles).

It causes additional loading of the roof's support structure, which requires performing calculations of the strength of the existing body. The calculations do not have to be performed in the case of the coachwork of gas buses, which have factory reinforced roofs for gas container installation.

As shown by the previous practice, installation of electrical machinery does not require significant interference in supporting structure. The reinforcement may be required for some transverse roof frames supporting a box with electrical equipment.

3.3. Building coachwork with an electric drive

3.3.1. Contactor drive – trolleybus MB 0405NE

One of the basic assumption while constructing the first trolleybus Mercedes O405N2 was applying the maximum possible number of elements of electrical machinery commonly used in Jelcz pr110 / M120 trolleybuses. In driving – high voltage electrical installations of these trolleybuses the following functional blocks can be distinguished. Their location is written in parenthesis:

- traction drive system including:
 - direct current traction engine (bottom)
 - set of starting resistors (roof)
 - set of resistors of traction engine shunt excitation circuit (rear),
 - high current (600 V) starting contactors (rear),
 - high current (600 V) reverser contactors (rear),
 - low current (600 V) contactors of traction engine shunt excitation circuit (rear),
 - overcurrent ratchet switch TWZ3 (cab),
 - fuses (600 V) traction engine shunt excitation circuit (rear),
 - electronic controller of starting contactors SET2 (rear),
 - overvoltage relay of supply voltage control PZU (rear),
 - overcurrent relay, so called automatic starting relay PSR (rear),
 - cables 600 V and 24 V,
- auxiliary drives system including:
 - low current contactors 600 V (rear),
 - fuses 600 V (rear),
 - compressor engine (side),
 - resistors of compressor engine shunt excitation (rear),
 - alternator and hydraulic pump engine (side),
 - resistors of alternator engine shunt excitation (rear),
 - heating elements,
 - cables 600 V and 24 V.

The following location symbolism of individual elements:

- rear – apparatus cubicle at the rear of the vehicle

- roof – the vehicle’s roof,
- cab – driver’s cab,
- side – apparatus cubicles situated on both sides of the middle part of a trolleybus,
- bottom – the area below vehicle’s ground.

The alternator powers an electrical installation of 24 V, a so called “car” installation. Apart from those appliances typical to of a bus (light, closing doors), this installation also powers the traction drive steering system. The following elements of the control panel in driver’s cab are also part of the power transmission system: Buttons on the driver’s control desk as well as driving and braking controllers connected with the vehicle’s control pedals.

During the construction work of Mercedes trolleybuses it was decided to perform a modified installation, as compared to Jelcz trolleybuses. The following elements were removed from withdrawn trolleybuses:

- which are no longer produced, namely:
 - o starting resistors,
 - o resistors of engines shunt excitation,
 - which replaced with their new equivalents would cause considerable financial outlay:
 - traction engine,
 - auxiliary engines 600 V,
 - high and low current installation contactors 600 V.

The main change introduced, as compared to Jelcz trolleybuses, was the modification of switching cycles of traction main circuit 600 V. Negative exploitation experiences connected with the high vulnerability of shunt excitation winding resulted in limiting its function in Mercedes trolleybuses to braking only. While starting, the winding is disabled, which means the engine works as a typical series machine. Another factor forcing changes in the main circuit configuration was the limited space for electrical machinery, which is due to the lower floor of Mercedes O405N buses and the construction limitations related to it. In order to limit the space occupied by electrical machinery elements, the number of starting stages was reduced from 12 to 10. Thanks to this the number of high currents 600 V was also reduced by two. The next change was resignation from the prone to failures and obsolete ratchet master switch 600 V, which was replaced by a contactor with an overcurrent release. It enabled situating the element to be situated in the rear part of the vehicle (in Jelcz trolleybuses it is situated in driver’s cab), which reduced the wiring length.

Significant changes in the control areas were introduced. Above all, the SET 2 drive controller was replaced by the self made EMT control module. Another change was the necessity of providing cooperation between ABS and ASR system and traction drive. Still another change was replacing PZU relay with an

electronic sub voltage contactor. One of the elements of power transmission system which are most prone to failure is PSR relay. Because of the limited time devoted to conversion, in the conversion of the first trolleybus an electromechanical PSR relay was used. In other vehicles the own made E-PSR module based on an LEM current converter.

Due to the limited volume of apparatus boxes the number of auxiliary engines of 600 V was limited. Instead of two auxiliary engines (one for the compressor and one for the alternator and the hydraulic pump) one engine common to these 3 appliances was used. The negative consequence of this change is the permanent work of the compressor, which results in increased noise level in the vehicle.

As compared to the electrical installation of Jelcz trolleybuses, many other changes were introduced such as applying new heating elements or current collectors with reflectors illuminating the contact system.

Table 2 shows the list of components used in the conversion of the first Mercedes O405N trolleybus.

Table 2. List of elements of electrical instalation used while converting the first Mercedes trolleybus by PKT

Item	Symbol	Name/type	Producer	Technical data	Number	New/ Regenerated
1	R11,R12	Shunt resistance 2/292	PKT Gdynia	150 Ω,400 Ω	4	R
2	R13	Shunt resistance 2/292	PKT Gdynia	25/25 A	2	R
3	L1-L6	Threaded nipple 6 – gear LZ-10b	PKT Gdynia		10	N
4		Compressor 602.07.901	Polmo Łódź		1	R
5		Station insulator SW4	Zofiówka Jedlina		5	?
6		Station insulator SW2	Zofiówka Jedlina		15	?
7		Insulator NF	Ciechów		16	?
8	B1-B6	Fuse contact screw	TROBBUS Gdynia		6	N
9	OZ	Valve arrester	Przasnysz	GXs 1,3	1	N
10	Dz	Ring CSD 01	PKT Gdynia	24 VDC; 15 s	1	?
11		Appliance sygnalizing vehicle's insulation condition EBW 201 E	KIEPE ELEKTRIC, Germany		1	N
12	B6	Fuse element	Elektrim	6 A	1	N
13	B2, 3, 4, 5	Fuse element	Elektrim	10 A	4	N
14	B1	Fuse element	Elektrim	20 A	1	N
15	B1-B6	Fuse holder 63A	Elektrim	63 A	6	?
16	A	Ammeter MER 72	ERA Warszawa	400-0-400 A 60 mV=	1	R
17	B1-B6	Fuse base	Elektrim	63 A,750 V	6	?
18	ŁG	Master switch	Bombardier	SUT 302	1	R

19	E02	Heating elements of the windscreen type 7250	Selfa Szczecin	200 W	18	N
20	E01, 03, 04, 05	Passenger lounge and driver's cab heater	ENIKA Łódź	2/3 kW	4	N
21	R2, 8, 7	Starting resistors DTB2	Bombardier	800 V	1	R
22	R1, 3, 4, 5, 6	Starting resistors DTB1	Bombardier	800 V	1	R
23	SB1, SB SOK, SOW, SOSZ, SSP SO1, SO2	Contactora SNF - 1E	Bombardier	600 V, 30 A Ust-24 V=	8	R
24	R16	Set of resistors	PKT Gdynia	10 Ω, 10 A	5x2	R
25	NJ, NH	potentiometr	VDO Germany	445,804	2	N
26	S1-S7, SH, SW, SN1-SN4	Contactora STT-152 W5	Bombardier	600 V, 150 A Uster-24 V=	13	R
27	SR2	Starting contactora STT-302 W4	Bombardier	600-750V ust-24V=	1	R
28	SR1	Starting contactora STT-302 W4	Bombardier	600-750V ust-24 V=	1	R
29	PSR	Automatic starting relay PST257a	Woltan Łódź	700 V=ust24 V	1	R
30	R14	Resistor – diode unit	PKT Gdynia	2 MΩ	1	N
31	R15	Resistor	PKT Gdynia	400 Ω	1	N
32	PZU	Voltage decay relay HRN-42	Relpol S.A.	24 VDC	1	N
33	SP	Auxiliary engine PRAZa 160m/2	Elmor S.A.	550 V , 6 kW	1	R
34		Booster pump of steering system	PTL Hydral S.A.	PZK1-12-101-2	1	R
35		Insulator of current collector base pallet	PKT Gdynia		4	N
36		Booster pump pulley	PKT Gdynia		1	N
37		Alternator pulley	PKT Gdynia		1	N
38		Compressor pulley	PKT Gdynia		1	N
39		Auxiliary engine pulley	PKT Gdynia		1	N
40		Current collector head	ESKO Czechy		2	N
41	Z+ Z-	Current collector rod	ESKO Czechy	Glass laminate	2	N
42		Current collector mechanism	PKT Gdynia		2	R
43		Pantograph rod base	PKT Gdynia		1	N
44		Auxiliary engine insulator	NABOR Kraśnik		8	N
45		Traction engine insulator PP-W	NABOR Kraśnik		4	N
46	G	Alternator	BOSCH	28 V, 95 A	1	R
47	PRH	Starting and braking programmer	PKT Gdynia		1	N
48		Booster pump and alternator assembly palette	PKT Gdynia		1	N

Source: Own work.

The course of vehicle conversion

Phase I – mechanical work

The first stage of mechanical work is the dismantling of the elements of the combustion power transmission system including the engine, gearbox and cooling system. The second stage is the modification of the engine space by removing unnecessary construction elements and dividing the space after dismantling the engine into three parts:

- rear main compartment destined for starting contactors, low current contactors 600 V, auxiliary circuits 600 V fuses, controller EMT,
- right side compartment for line contactor and relays PSR and PZU,
- left side compartment for auxiliary engine together with alternator, compressor and hydraulic pump.

The advantage of Mercedes MB405N2 buses is a very spacious engine compartment, which reduces the range of necessary mechanical works connected with the adaptation of bus' coachwork.

One of the elements of mechanical work is changing the rear axle ratio. An electrical traction engine has greater rotational speed than combustion engine; as a result, it is necessary to change the final drive ratio. The modification is relatively easy to carry out it only involves exchanging gear wheel in the final drive.

An important issue when converting a bus into a trolleybus is the adaptation of the vehicles' roof. During conversion the following electrical machinery is installed:

- current collectors,
- starting and braking resistors,
- in the case of vehicles with power electronic drive: traction converter and inverter.

It is also necessary to make 600 V cable outlets.

While preparing the roof adaptation it is necessary to consider the following aspects:

- strengthening roof construction:
- replacing or blanking sunroofs.

As far as roof adaptation is concerned, gas buses are the easiest to adapt. They have factory reinforced roofs for gas container installation and a small number of sunroofs.

Phase II – assembling the main elements of 600 V installation

As mentioned previously, the main elements of a trolleybus's main circuit are taken from Jelcz trolleybuses that are no longer in use. They are regenerated before installation. In the case of contactors and starting resistors the regeneration is performed in-house and consists mainly of servicing and possibly, the replacement of moving parts. An external company performs traction engine reparation including their rewinding.

The individual elements of the main circuit are arranged in the following way:

- the traction engine is situated in the area previously occupied by the bus's gearbox. In order to protect the engine from humidity, a cover plate is installed under the engine,
- main circuit and auxiliary circuits contactors 600 V are situated in the rear compartment in the place of the combustion engine, the line contactor is placed in the right side compartment,
- starting resistors are situated on the roof,
- contactors of traction engine and auxiliary engine shunt excitation circuits are installed in the rear compartment,
- the auxiliary engine together with its auxiliary elements is installed in the rear part of vehicle's roof.

New wiring of 600 V circuits and 24 V control system is made.

Phase III – installation of control system elements.

The majority of control system elements are produced in-house in the PKT electronic workshop, in particular:

- starting contactors steering module EMT,
- relay PSR,
- relay PZU.

The following elements of the driver's cab equipment are also adapted:

- driving and braking controllers connected to the accelerator and brake pedals are installed. For this purpose, controllers identical to those used in Solaris Trollino trolleybuses are used;
- power transmission system control buttons such as master switch controller are situated on driver's control desk;
- if possible, the primary functions of control elements situated on the driver's desk are used; for example, the control button of automatic gearbox D-N-R is adapted to control the reverser;
- an insulation condition control system is installed.

All steering elements working with the traction drive control system have to be equipped with insulation for contact system full voltage (600 V) regarding the body. This is a result of the necessity to provide two stage electrical insulation. Therefore, the control buttons on the driver's desk are equipped with additional insulation spacers; driving controllers are analogically insulated.

Further issues connected with protection against electric shock are:

- equipping the area at the entrance door with additional insulation surfaces,
- insulation of the entrance door railing,
- insulation of the inside railing within the reach of a passenger standing on the pavement and getting on the bus.

3.3.2. Chopper drive – trolleybuses MB O405NI

Analogically to the first series of trolleybuses MB O405NE which were equipped with a drive with direct current traction engine, the trolleybus MB O405NI was also based on an identical traction engine DK210. The remaining part of traction electrical installation was changed due to the use of:

- an impulse system of supply with a traction engine velocity system instead of the previous contactor – resistor system;
- a static converter instead of electromechanical system with alternator;
- auxiliary engines produced using alternating current technology.

The impulse traction engine converter was provided by the Electrical Engineering Institute in Warsaw. Due to the desire to minimize costs, a simplified converter without a regenerative braking option was used, thanks to which the number of transistor modules IGBT was reduced to one. The converter based system of traction engine velocity regulation enables:

- starting until the natural engine performance is reached;
- one stage field weakening using a shunt activated with a contactor;
- electrodynamic resistor braking during which a traction engine works as a separately excited machine induced by series winding powered from the contact system by an impulse converter.

Electrodynamic braking is realized until the velocity is lower than 3 km/h; after which the exciting current is switched off. The power transmission system is steered using a set of module controllers PLC. An additional element used with the installed traction drive was the antistatistical filter of input voltage.

In order to provide two stage galvanic separation of circuits 24 V an additional separating converter 24 / 24 V / V was used. It powers control circuits working on contact system voltage potential.

A further significant change was the use of a static converter and alternating current auxiliary engines. The static converter produced by ZEP company possesses the following characteristic elements:

- the output 24 V DC for powering control installation circuits and drive control systems;
- the output 400 V AC for powering auxiliary engines;
- two stage output voltage insulation in terms of contact system voltage.

Electrical machinery elements were arranged in the following way:

- traction engine, analogically to trolleybuses MB O405NE, was situated in the rear on the left, in the space previously occupied by the bus's gearbox;
- impulse converter together with a controller – in the rear part of the vehicle in the space previously occupied by the combustion engine on the right;
- antidisturbance DC filter – in the centre of the rear part of the vehicle, in the space created by dismantling the combustion engine;
- separating converter 24 V / 24 V – in the rear part of the vehicle, in the space previously occupied by the combustion engine on the right;
- main and auxiliary circuits 600 V contactors – in the rear part of the vehicle, in the space previously occupied by the combustion engine on the right;
- main converter – on the vehicle's roof.

The phases of the vehicle's conversion were identical to those of trolleybuses MB405NE.

3.3.3. Asynchronous drive – trolleybus MB MB405NAC

The experience gained during construction and the first months of the exploitation of trolleybus MB O405NI confirmed the propriety of using power electronic drives in constructed vehicles. Nevertheless, the major disadvantage of this trolleybus was using the direct current traction engine DK 210. It is an obsolete machine that is no longer produced, which results in high failure frequency. The thorough analysis of the construction costs of trolleybus MB O405NI showed that the cost of electrical machinery for this vehicle is only slightly lower than the price of a brand new drive together with the alternating current engine and additional equipment. In addition, purchasing the brand new machinery from one supplier would eliminate problems connected with compatibility of individual appliances. Based on this experience, it was decided to build trolleybuses MB 405N based on new power electronic machinery equipped with an alternating current traction engine.

During preparatory work the following main requirements concerning the electrical installation of a trolleybus were specified:

- traction engine power: 160 – 180 kW;

- vehicle's regenerative braking;
- the equipping of the trolleybus with air conditioning in the driver's position;
- the equipping of the trolleybus with automotive batteries enabling it to cover a distance of 1000 m in case of failure;
- the supplier of electrical machinery is responsible for supplying all elements i.e. contactors 600 V.

The supplier of the machinery was selected in public tender.

In the electrical equipment ENI-ZNAP/TB/165 provided by ZEP Enika company the following elements are included:

- drive inverter ENI-FN 600/165/G;
- main converter ENI-PTL 600/21/G;
- separating converter ENI-PTL 24/24DCSG;
- contactor PLC of trolleybus ENI-PLC/3U/8M built on SNT board;
- operating panel ENI-PO800/480;
- driver's cab heater ENI-NN600/3-1/G;
- 2 heaters of passengers compartment ENI-NN600/3-1/G;
- contactors and protection boards - TPS, CT1115, WTS, TSPB, SNF;
- battery accumulator 60STH800 produced by SAFT company;
- inverter input choke ED1W-2,9/170;
- braking resistor RHEN/G;
- air conditioning unit CC4E;
- starting and braking controllers.

The trolleybus is powered by an asynchronous traction engine STDa 280 6B, produced by EMIT Žychlin, with power of 165 kW.

The electrical machinery ZNAP/TB/165 is the complete equipment necessary for the proper functioning of the trolleybus drive. The machinery is situated on boards adjusted to be installed in the free spaces of a trolleybus.

The system consists of the following boards:

- TPS board – of separating converter;
- contactors CT1115 board;
- fuse board;
- contactors and protections TSPB board;
- contactors TSNF board;
- SNT board.

Trolleybus work is managed by the PLC ENI-PLC3U/8M controller situated on the SNT board influencing the system components through digital and analogue inputs and outputs as well as two CAN communication buses.

- CAN 1- communication with drive inverter;
- CAN 2 – communication with converter and operating panel.

The work of the power transmission system can be monitored with the help of the operating panel situated in driver's cab.

Traction inverter ENI-FN600/165/G supplying the asynchronous traction engine with alternating voltage of adjustable frequency has its own microprocessor controller working under control of Trolleybus Drive Controller (SNT). Communication is held along CAN bus.

The technical data of traction inverter:

- nominal supply voltage: 600 V DC;
- range of supply voltage variation: 380 ÷ 750 V DC;
- nominal output supply: 3x400 V 50 Hz;
- output frequency: 0 ÷ 200 Hz;
- nominal output power 165 kW;
- maximum output power: 320 kW;
- maximum instantaneous current amplitude: 500 A;
- communication with drive controller: CAN bus;
- Cooling: blast cooling;
- degree of cover protection: IP54;
- mass: about 140 kg.

Static converter ENI-PTL600/21/G powers the following voltage outputs:

- direct current 24 V to supply control circuits;
- three stage 3x400 V 50 Hz to supply the piston compressor and booster pump of the trolleybus steering system;
- direct current 80 V to charge emergency drive battery;
- three stage voltage 3x400 V 50 Hz (usage as above) from the battery during emergency drive.

The converter enables current monitoring of the work status and parameters with the help of an operating panel connected to the CAN network.

Converter technical parameters:

- nominal supply voltage: 600 V DC;
- range of supply voltage variation: 380 ÷ 750 V DC;
- output AC 1 booster pump supply:
 - o nominal output supply: 3x400 V 50 Hz;
 - o nominal wire current: 5 A;
 - o output overload capacity: 300 % in 1 s;
 - o maintaining work in a situation where there is traction voltage decay in the vehicle's accumulators with manageable time in the range of 1-15 s;
- output AC 2 piston compressor supply:
 - o nominal output supply: 3x400 V 50 Hz;
 - o nominal /wire current: 7,5 A;
 - o output overload capacity: 300 % in 1 s;

- additional separated output 230 V AC with power of 1kVA produced in AC 2 output;
- output DC 24 V:
 - o nominal output supply: $27,8 \pm 0,5$ V;
 - o nominal voltage: 24 V DC;
 - o nominal output current: 180 A;
 - o protection against shorting of the output terminal;
- output DC 80 V:
 - o nominal output supply: $93 \pm 0,5$ V;
 - o nominal voltage: 80 V DC;
 - o nominal output current: 16 A;
- Cooling: blast cooling;
- degree of cover protection: IP54;
- mass: about 180 kg.

The converter is installed on vehicle's the roof.

Inside the cover the complete converter system is installed. It consists of six circuits:

- circuit converting the power voltage into intermediate voltage 600 V DC;
- circuit converting the intermediate voltage into output voltage 3x400 V 50Hz;
- circuit converting the intermediate voltage into output voltage 24 V DC;
- circuit converting the intermediate voltage into output voltage 80 V DC;
- circuit converting the vehicle accumulators voltage into intermediate voltage 600 V DC;
- circuit converting the emergency battery drive voltage into intermediate voltage 600 V DC.

The separated circuits of a trolleybus's on board installation (24 V DC) requiring double insulation from the contact system are supplied by the separating converter ENI-PTL24/24DCSG with the following technical data:

- supply voltage 24 ± 6 V DC;
- output voltage 24 ± 1 V DC;
- nominal output current 35 A;
- maximum output current 45 A;
- insulation proof voltage 2.5 kV / 50 Hz / 1 min;
- degree of cover IP43 protection;
- mass 19 kg.

The trolleybus is provided with automative batteries enabling the emergency drive without supply from the contact system. Nickel cadmium cells were used because of their very long life of up to 15 years if the appropriate working system is applied. The battery container consists of 60 cells STH800 produced

by SAFT company, of total mass 380 kg. While driving on battery supply the power transmission system is powered directly from the battery with voltage 72 V, which results in significant reduction of its parameters. However, in practice it turned out that it is possible to reach the velocity of 20 kph which is satisfactory in emergency situations.

The electrical machinery is arranged in the following way:

- a traction converter, automotive batteries, main and auxiliary circuits 600 V contactors and a drive controller are situated in the rear apparatus cubicle;
- the main static converter and braking resistor are situated on the roof;
- the auxiliary engines together with a compressor and booster pump of hydraulic system are installed on one side of the vehicle;
- the operating panel is situated in the driver's cab.

3.3.4. Asynchronous drive – trolleybus MB O530 Tr12/TV.EU

The positive experiences associated with the exploitation of trolleybuses MB O405N equipped with a drive with an alternating current engine confirmed that it was a good solution. Nevertheless, in continuing the project the purchasing of Mercedes MB O405N2 coachworks in good technical condition proved to be a problem. This is due to the fact that these vehicles are no longer produced. Therefore, it was decided to begin preparations for the construction of trolleybuses based on of the next model MB O405N, which is a MB 530 bus.

The following elements of electrical machinery identical to those installed in MB O405N trolleybuses were used in the conversion: the power transmission system produced by ZEP Enika equipped with alternating current engine, static converter and nickel cadmium automotive batteries. The major difference in relation to electrical installation, as compared to previous solutions, is air conditioning of the passenger compartment. It resulted in increasing the power of the static converter. As compared to the previous solution, the number of automotive battery cells was increased from 60 to 65.

The coachwork of the Mercedes O530 bus is manufactured with a low floor throughout, which results in the significantly worse arrangement of the apparatus space in terms of electrical machinery installation. As a result, it was decided that the interior of the vehicle would be rearranged, in an effort to obtain the space required for installing elements of electrical equipment and maintaining the high functionality of the passenger compartment. The vehicle's adaptation consisted in:

- lowering the engine tower situated in the rear part of the vehicle and, consequently, installing additional windows;

- constructing a box for automotive batteries in the area occupied by three rear seats situated behind the last door;
- dismantling the fuel tank situated over the front wheel arch in order to obtain space for installing four more seats for passengers.

Taking into consideration the possible that the capacity of batteries may increase in the future, additional space for installing the second module of batteries consisting of 65 nickel cadmium cells was prepared.

The smaller space for electrical machinery resulted in installing the traction inverter and static converter on the roof. Both appliances are installed in two independent waterproof containers.

3.3.5. Asynchronous drive – trolleybus MB O530AC

The positive experiences associated with the exploitation of trolleybuses MB O405N equipped with a drive with an alternating current engine confirmed that it was a good solution. Nevertheless, in continuation of the project the purchasing of Mercedes MB O405N2 coachworks in good technical condition proved to be a problem. This is due to the fact that these vehicles are no longer produced. Therefore, it was decided to begin preparations for the construction of trolleybuses based on of the next model MB O405N, which is a MB 530 bus.

The following elements of electrical machinery identical to those installed in MB O405N trolleybuses were used in the conversion: the power transmission system produced by ZEP Enika equipped with alternating current engine, static converter and nickel cadmium automotive batteries. The major difference in relation to electrical installation as compared to previous solutions is the air conditioning of passenger compartment. It resulted in increasing the power of the static converter. As compared to the previous solution, the number of automotive battery cells was increased from 60 to 65.

The coachwork of the Mercedes O530 bus is manufactured with a low floor throughout, which results in the significantly worse arrangement of the apparatus space in terms of electrical machinery installation. As a result, it was decided that the interior of the vehicle would be rearranged, in an effort to obtain the space required for installing elements of electrical equipment and maintaining the high functionality of the passenger compartment. The vehicle's adaptation consisted in:

- lowering the engine tower situated in the rear part of the vehicle and, consequently, installing additional windows;
- constructing a box for automotive batteries in the area occupied by three rear seats situated behind the last door;

- dismantling the fuel tank situated over the front wheel arch in order to obtain space for installing four more seats for passengers.

Taking into consideration the possible that the capacity of batteries may increase in the future, additional space for installing the second module of batteries consisting of 65 nickel cadmium cells was prepared.

The smaller space for electrical machinery resulted in installing the traction inverter and static converter on the roof. Both appliances are installed in two independent waterproof containers.

3.4. Setting the trolleybus in motion - phase of stationary and movement tests

Before introducing the vehicle into exploitation it is necessary to conduct the following tests:

- trolleybus installation 600 V insulation tests:
 - insulation resistance measurements;
 - insulation spacing test;
 - Insulation resistance measurements of the railing within the reach of a passenger standing on the pavement;
 - voltage tests;
 - insulation resistance measurements of railing and entrance steps;
- analysis of functioning and structure of the main and control circuit;
- tests of signalling voltage 60 V overflow relative to the road's surface;
- possibility test of galvanic disconnection of installation 600 V from current collectors circuit in both poles;
- test of voltage decay signalling in current collectors circuit;
- test of ground connection of heater 600 V cover, if they are installed directly in passenger compartment or in the driver's cab;
- test of pole retrievers mechanism functioning (in a case where a trolleybus is fitted with this mechanism);
- network drive / autonomous drive relation test – checking if the automative battery circuit is galvanically disconnected from the network during the network drive (in a case where a trolleybus is fitted with an autonomous driving system);
- tests of auxiliary appliances noise during vehicle standstill;
- tests of electromagnetic compatibility;
- vehicle mass measurement – axle loads;
- movement tests:

- braking deceleration tests;
- test of purely electrodynamic braking deceleration;
- testing the priority of braking over starting;
- standard tests on a bus diagnostic station.

The bus coachwork selected for conversion must be technically efficient and registered. On the basis of the aforementioned tests The Institute of Physical Planning and Housing issues the admittance to service, on the basis of which the vehicle is registered.

When launching subsequent vehicles of the same type the measurements of electromagnetic compatibility, noise and vehicle mass are not performed.

4 | Process of trolleybus registration

In order for the converted trolleybus to be permitted to carry passengers it is necessary to complete all legal formalities and technical tests. The procedures should be completed before starting conversion in order to enable the vehicle's registration and normal exploitation.

4.1. Trolleybus official certification tests conducted by authorised institutions

The conversion of a bus into a trolleybus involves extensive changes and interference with the vehicle. In order to make the converted vehicle safe numerous conditions have to be met. It should be confirmed by technical tests and the positive opinion of appropriately qualified experts. According to current law, typical certification is not necessary. It is sufficient to perform the extended tests of a trolleybus converted from a bus and admitted to service, gain a verification from an expert as well as admittance from a diagnostic station.

Taking into consideration the variety of converted coachwork, the converter should regularly consult those people and institutions responsible for admitting such vehicles to service. This helps to avoid further problems with the admittance.

The positive opinion of an expert is necessary to register a vehicle, because it contains new technical parameters and a confirmation that the conversion has been performed correctly. The expert pays the special attention to construction changes which may significantly influence the safe functioning of the vehicle. They analyse the new vehicle's roof construction and reinforcement in order to ensure it does not exceed the permissible load. Replacing mechanical subassemblies with electrical ones results in a complete change in the vehicle's kerb weight as well as each axle load. These figures also cannot exceed those allowed for the particular type of coachwork. In order to set the capacity of the vehicle it is necessarily to count passenger seats, measure the new vehicle mass and all axle loads. It is important not to modify the supporting structure of the

vehicle while converting a bus into a trolleybus. The new appliances should be properly and securely mounted, preserving the original structure, if possible.

Trolleybus extended tests aim to confirm if the newly installed equipment typical of trolleybuses together with its installation meet all the legal requirements and if they are safe in their exploitation.

The first stage of the test is the thorough analysis of the technical documentation of trolleybus equipment. The system of individual appliances electrical connections (both internal and among individual elements) is assessed in terms of conformity with applicable regulations and it determines the further course of tests. Some failures are detected at this stage. It should be mentioned that regular contact and good relations is significant for all parts involved. It often helps to avoid significant construction mistakes and find optimal solutions, considering the present economical, organisational and technical conditions. The scheme below presents the sample insulation model created for extended tests and arrangements of the building of a trolleybus MB O405N with impulse (direct current) drive made by IEL and static converters made by ENIKA. The scheme contains the information concerning the violation of standard and non-standard trolleybus insulation performance and is only the explanatory information, an addition to the full documentation of circuits connected with typical trolleybus equipment.

The second stage of tests may begin immediately after installing and launching all trolleybus equipment. These are tests of compliance with the previously declared technical documentation. Then possible corrections are applied. The first measurements of insulation resistance of every step, the whole bus and individual appliances. The following elements are analysed: cable routing way, surface, clearance to earth and air insulation spacing, insulation materials applied and ready insulators.

The third stage consists in voltage tests of particular insulation stages of equipment working on contact system potential and being intermediate masses between insulation stages as well as circuits powered by three-stage voltage (e.g. circuits of compressor auxiliary engines and a booster pump powered by voltage 3 x 400 V; 50 Hz). The level of test voltages is defined by law. This test should end with retesting insulation resistance as it could have been damaged or significantly weakened during voltage tests. The following elements should be additionally tested:

- door railing insulation resistance in terms of the vehicle's ground;
- floor insulation resistance at the entrance to a trolleybus;
- functioning of the declared contact voltage detecting the voltage between the road surface and trolleybus earth. The detection a dangerous contact voltage should be alerted acoustically and visually in the driver's cab.

The positive results of the aforementioned test may be the temporary certificate confirming that the vehicle is allowed to drive without passengers only to perform further tests. Conducting tests in a vehicle inspection station requires the aforementioned certificate and expert's opinion. The test consists of verifying the changes introduced in the vehicle and a standard test similar to periodic examination (checking: braking system functioning, lighting, VIN numbers, documents, etc.).

The fourth stage consists of trolleybus movement tests. Because of the necessity of driving on public roads, this stage should be preceded by standard tests of a trolleybus on the diagnostic station and registration of the vehicle as a trolleybus. The following movement parameters are tested:

- 1) delay in electrodynamic braking, the value of which is defined by law;
- 2) the priority of braking over starting.;
- 3) the level of noise emitted during vehicle standstill;
- 4) lack of faults of the the power transmission system resulting in unexpected interruption of starting and especially braking;
- 5) voltage regulation in contact system during electrodynamic regenerative braking (braking energy recuperation). The braking energy recuperation to the contact system should not exceed the voltage defined by law. The excess of braking energy should be lost in the braking resistor.
- 6) the functioning of the trolleybus with lower contact system voltage. An acoustic alert should sound in the driver's cab. As the voltage is lowered, the first to fade should be starting, then steering system support. If the electrodynamic braking begins, it should continue.

The fifth and the last stage is conducting of tests of the trolleybus's electromagnetic compatibility (EMC) by an appropriate institution. It concerns trolleybuses with power electronic equipment which may emit electromagnetic disturbances. It must be noted that any change of power electronic software resulting in the change of the semiconducting switches switching method invalidates the tests of trolleybus's electromagnetic compatibility because it may result in a change in the character of electromagnetic disturbances. Exceeding the permitted level of electromagnetic disturbances may result in the incorrect functioning of a tested trolleybus, other trolleybuses and other appliances situated close to the emitting trolleybus. The potential effects are difficult to predict, but they may be dangerous or even disastrous.

The positive effect of extended tests may result in full approval to operate trolleybuses with passengers.

4.2. Registration of a trolleybus as a vehicle with an electric drive

In Poland, the registration of a vehicle is necessary to use it on public roads. This also concerns a bus converted into a trolleybus; however, as in the case of a trolleybus the relevant admittance tests are required. As in the case of other vehicles, when the bus selected for conversion changes its owner, it must be reregistered. As a result, the converter becomes the owner of the registered trolleybus. In order to register a bus intended to be converted into a trolleybus, one should:

- 1) buy a bus;
- 2) reregister the bus (still as a bus) under new ownership;
- 3) convert the bus into the trolleybus;
- 4) obtain a positive expert opinion;
- 5) obtain a temporary admittance to service for the duration of the test period.
- 6) obtain positive test results on a vehicle inspection station;
- 7) register the converted vehicle as a trolleybus;
- 8) obtain positive extended test results:

During further exploitation of the vehicle standard procedures of registration are applied.

5 | Exploitation experiments

The conversion of a used bus into a trolleybus always brings to light questions, doubts and expectations concerning its future exploitation; especially if it is a prototype conversion as far as the coachwork and drive are concerned. The conversion of a used coachwork with which one is not wholly familiar, in terms of its electrical and mechanical structure, often results in changes in the conversion plan and a risk of unpredictable exploitation problems, caused by the new solutions chosen. The situation is different in the case of contact systems the structure and functioning of which is well known and the possible risk connected with prototype solutions is the worry of drive manufacturers.

5.1. Exploitation experiments in Gdynia

The first bus converted into a trolleybus was a Mercedes – Benz O405N. The conversion was the result of the situation the company found itself in at the time; namely the lack of low floor rolling stock and the exploitation of worn out Jelcz trolleybuses. The result of the analysis was that the fastest and cheapest method of obtaining the low floor is conversion of used low floor buses into trolleybuses and using the electric traction machinery dismantled from written off resistance high floor trolleybuses. The electrical system of traction drive and the auxiliary system was only slightly modified as compared to the previous one.

The advantages and disadvantages were, in fact, identical making a well known, simple, rather reliable, easy to repair and energy intensive system. However, the exploitation of coachwork MB O405N was a new experience. The main problem was the great variety of origin, production, degree of wear and tear and number of alterations (often provisional) made by previous owners. In fact, each conversion required an individual approach. An additional problem was mechanical repairs; the frequent failures of mechanical subassemblies and huge variety of spare parts resulted in extending the

assortment as well as the store. At first, "Mercedeses" were treated by the majority of workers as a punishment or necessary evil.

It was experimental and progressive to use a very simple impulse drive (without returning the energy of electrodynamic braking to the network) with a regenerated traction engine rewound to series motor in one trolleybus. The static converter as well as asynchronous auxiliary engines were also used. Except for a drive inverter, a static converter and auxiliary engines, the written off trolleybuses provided many appliances used in converted trolleybuses.

Another example of progression and experimentation was the use of the entirely new traction equipment with asynchronous traction engine, static converter and asynchronous auxiliary engines as well as an emergency power traction battery. This system recovers the electrodynamic braking energy to the contact system and has the possibility of driving short distances without the contact with the contact system or damaged current collectors.

5.1.1. Failure frequency of electric drive elements

In the case of resistance drives in trolleybuses MB O405N, the contactors making the greatest number of switchings are particularly prone to failure. These failures are mainly the sticking together or premature wear of the main contacts. Failures of the control system are also frequent. These are mainly circuit gaps, dirty auxiliary contacts and relay failures. The frequent failures of traction engines are the result of heavy load (on the verge of overload), structural defects, insufficient servicing and very low level of repairs conducted by external companies. Nowadays new servicing procedures have been introduced and the procedures included in engine repair contracts ensure high quality. There are also failures of direct current auxiliary engines; however, their number is lower due to the introduction of new procedures connected with engine servicing and repair. The problem of lowering insulation resistance during precipitation is also worth mentioning.

The impulse system used in one trolleybus is practically prone to failure except for traction engines, where the situation is as bad as in resistance drives.

The failure frequency or often defectiveness of asynchronous drives is connected mainly with disclosing appliance and program faults difficult or impossible to eliminate while designing and in the first stage of exploitation. There were also defects connected with element failure, material faults or careless performance. The most serious problem that appeared in the first year of exploitation caused by heat (+28°C in the shade + strong solar radiation) was the overtemperature protection that worked during the normal functioning of

appliances which caused pauses in the functioning of drives and static converters. It resulted in programme changes of the appliances as well as the extension of air conditioning. The failure frequency of the drives of such kind may rise after a few years of exploitation because of the natural wear of elements. It is, currently, too early to talk about failure frequency as the series of faults was caused by the introduction of the new solution.

5.1.2. Failure frequency of mechanical elements

Building the used coachwork with electrical machinery, we are conscious of the fact that we cannot be certain of the exact physical condition of its mechanical subassemblies and construction. Especially in the case of vehicles purchased as a result of tender procedure, the vehicle's past remains unknown. The aforementioned factors influence the failure frequency which is difficult to predict and different for individual trolleybuses that were obtained by conversion.

In addition, some auxiliary systems subassemblies previously powered by combustion engine were replaced with other ones or adjusted to being powered by electric motor, which influenced the general failure frequency of converted trolleybuses.

As early as with one of the first conversions there appeared a problem with two-piston compressors that worked close to the limit of allowed parameters. The change of compressor parameters as compared to Jelcz trolleybuses, where they were successfully applied, turned out to be significant and it consisted of:

- increasing the working pressure to approximately 15%;
- constantly increasing the ambient temperature (the only possibility was to build near other appliances emitting heat);
- increasing the demand for compressed air (additional ECAS system);
- change of working mode from short time duty (only for time of pumping up) to continuous running with periods of idle running - without pressure;
- increasing the degree of dirt in the surroundings.

The new working conditions, especially in the summer, evoked mass failures of two-piston compressors, which sometimes resulted in the temporary stoppage of trolleybuses. These problems forced the change of compressor type into others powered by outer engine by the belt transmission (one-piston and with outer lubrication). The new compressors also turned out to cause failures until the proper lubricating oil was selected and the cooling fan was replaced with a stronger one.

Replacing bus drives with an automatic gearbox with trolleybus drives with direct current traction engines forced the change of driving axle transmission by

replacing some elements. Another significant change was introducing coasting drive. These factors as well as the fact of natural wear influenced the significant failure frequency of driving axles in trolleybuses with direct current traction engines.

In the case of replacing the bus drives with automatic gearboxes with trolleybus drives with asynchronous engines $2p=6$ the change of driving axle transmission is not necessary. The exploitation experiments have not showed the worrying failure frequency; however the symptoms of wear of driving axles such as greater noise level and vibrations, especially on the coasting, were observed. The drives applied allow for the elimination of coasting liquidation by leaving a small moment (practically unnoticeable to the driver) on the traction engine shaft in order to reduce clearances, noise and vibrations.

Failure frequency analysis

It was observed that the characteristic feature of failure frequency of trolleybuses in Gdynia are a temporary series of failures of one type. In case of buses converted into trolleybuses it is often a result of changes in weather conditions depending on the season, subassemblies manufacturing defects, structural defects or other kinds of imperfections such as lack of exploitation tests of prototypes, accepting temporary solutions and not removing structural defects when they were noticed. The frequent reason of the series of failures is superposition of potentially harmless factors.

It is necessary to know about the present failures and their causes in order to combat excessive failure frequency effectively. For this purpose the failure frequency analyses aimed at detecting exploitation problems are conducted. Below we present sample results of the analysis in the form of tables and charts prepared to meet the needs of the section responsible for technical maintenance of trolleybuses. Presenting all the results in this book would serve no logical purpose.

Table 3. Failure frequency indexes of trolleybuses operated by PKT

Groups of trolleybuses – failure frequency indexes							
Period of analysis		since 2011-01-13			to 2011-02-14		
Groups of trolley-buses	Number of vehicles	Kilometrage	Average kilometrage	Average daily kilometrage	Number of failures	Number of failures per vehicle	Number of failures per Mm
		Mm	Mm per vehicle	Km per vehicle			
Jelcz (J)	20	47	2,33	70,46	47	2,35	1,01
Mercedes (M)	23	129	5,63	170,55	80	3,48	0,62
Mercedes + ENIKA (ME)	5	29	5,78	175,28	22	4,40	0,76
Solaris + CEGELEC (SC)	16	108	6,72	203,69	61	3,81	0,57
Solaris + IEL (SI)	4	13	3,37	102,20	15	3,75	1,11
Solaris + MEDCOM (SM)	21	128	6,09	184,66	27	1,29	0,21
ALTOGETHER	90	454	5,04	152,82	252	2,80	0,56

Source: Own work.

Table 4. Failure frequency of particular types of trolleybuses operated by PKT

Failure frequency of particular types of trolleybuses on route															
Number of individual failures			since 2011-01-13 to 2011-02-14												
No.	Cause of failure		Type of trolley bus	J		M		ME		SC		SI		SM	
			Overall number of failures	LA/(L T*P)*1000 index	Number of LA failures	LA/(L T*P)*1000 index	Number of LA failures	LA/(L T*P)*1000 index	Number of LA failures	LA/(L T*P)*1000 index	Number of LA failures	LA/(L T*P)*1000 index	Number of LA failures	LA/(L T*P)*1000 index	Number of LA failures
1	OS	outside and inside lighting + supply installation + steering	24	3,225	3	2,351	7	13,83	2	2,906	5	18,53	1	2,233	6
2	D	door + steering	25	3,225	3	4,367	13	6,915	1	1,743	3	18,53	1	1,488	4
3	H	braking system + steering + supply	6	0	0	0,672	2	0	0	1,743	3	18,53	1	0	0
4	ZAN	pollution	1	0	0	0	6,915	1	0	0	0	0	0	0	0
5	LIN	pole ropes; ropewinders	7	1,075	1	0	0	6,915	1	0,581	1	18,53	1	1,116	3
6	URS	steering of resistance starting system	4	3,225	3	0,336	1	0	0	0	0	0	0	0	0
7	OG	tyre; wheel	3	0	0	0,672	2	0	0	0	0	0	0	0,372	1
8	REZ	starting, braking and	1	0	0	0,336	1	0	0	0	0	0	0	0	0

		auxiliary resistors													
9	PAN	trolley pole; base	5	1,075	1	0	0	0	0	1,162	2	0	0	0,744	2
10	PAS	V – belts; belt pulleys	0	0	0	0	0	0	0	0	0	0	0	0	0
11	POD	pneumatic suspension + ECAS + steering	7	1,075	1	1,344	4	6,915	1	0,581	1	0	0	0	0
12	AL	alternator + charging system	2	1,075	1	0,336	1	0	0	0	0	0	0	0	0
13	SIL	traction or auxiliary engine	2	2,15	2	0	0	0	0	0	0	0	0	0	0
14	SP	compressor	3	0	0	0,336	1	0	0	0,581	1	0	0	0,372	1
15	SIP	information boards + installation + steering (of ticket puncher as well)	9	0	0	2,687	8	0	0	0,581	1	0	0	0	0
16	UNE	power electronic drive appliance	11	0	0	0	0	13,83	2	1,743	3	37,06	2	1,488	4
17	UP	pneumatic system	7	0	0	2,015	6	0	0	0	0	0	0	0,372	1
18	PS	static converter	8	0	0	0	0	0	0	1,743	3	92,66	5	0	0
19	WYC	wipers; mirrors	7	1,075	1	0	0	0	0	1,743	3	0	0	1,116	3
20	ZB	collector	27	1,075	1	1,679	5	20,75	3	5,811	10	37,06	2	2,233	6
21	ZS	entangled in network	8	5,376	5	0	0	0	0	1,162	2	0	0	0,372	1
22	KAS	ticket punchers + installation + steering	19	1,075	1	3,023	9	13,83	2	1,743	3	0	0	1,488	4
23	NIEZN	unknown	3	0	0	0,336	1	0	0	0,581	1	0	0	0,372	1
24	KOL	collision	8	2,15	2	1,008	3	0	0	1,743	3	0	0	0	0
25	INNE	other	5	0	0	0,672	2	6,915	1	0,581	1	0	0	0,372	1
26	IWN	electrical installation 600 V JA + electrical connections	0	0	0	0	0	0	0	0	0	0	0	0	0
27	INN	electrical installation 24 V + electrical connections	4	0	0	0,672	2	0	0	0,581	1	18,53	1	0	0
28	IUP	electrical installation subassemblies – auxiliary system	4	0	0	0	0	0	0	0,581	1	18,53	1	0,744	2
29	ELEK	remaining electrical subassemblies	14	5,376	5	2,687	8	0	0	0	0	18,53	1	0	0
30	MECH	remaining mechanical subassemblies	3	0	0	0	0	20,75	3	0	0	0	0	0	0
31	STY	contactor; switch	7	1,075	1	1,679	5	0	0	0	0	18,53	1	0	0
32	BLA	metal plates; finish; inside equipment	12	1,075	1	1,344	4	0	0	3,487	6	0	0	0,372	1
33	ZAM	freeze - up	1	1,075	1	0	0	0	0	0	0	0	0	0	0
Altogether			247	33	85	17	54	17	41						
				247											
Kilometrage P [Mm]			454	47	129	29	108	13	128						
Number of trolleybuses LTT-1			90	20	23	5	16	4	21						

Source: Own work.

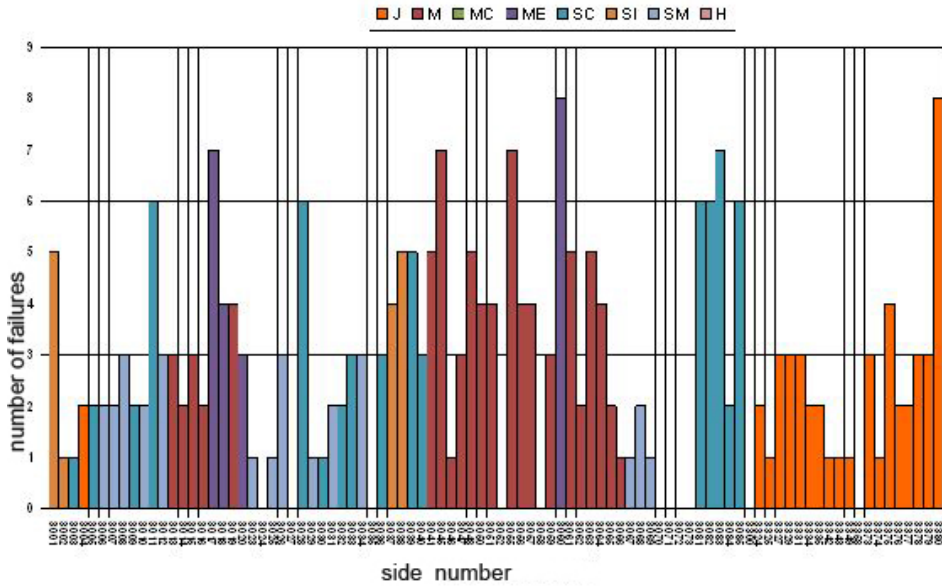

Fig. 2. The number of failures of trolleybuses operated by PKT

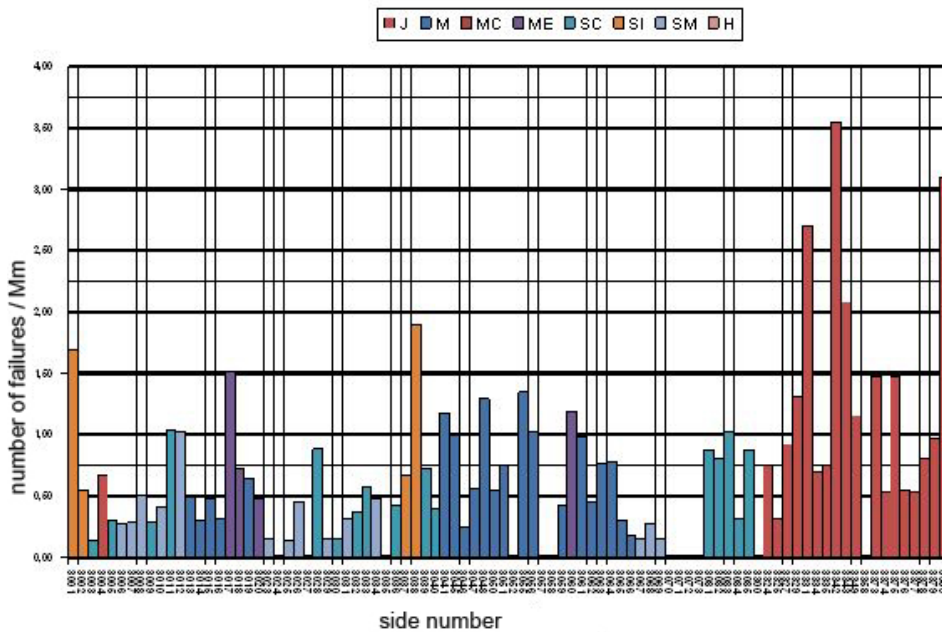

Fig. 3. Failure frequency indexes of trolleybuses operated by PKT

On the basis of data collected in a period of a few months for the purpose of this book we present two charts with data concerning failure frequency of particular groups of trolleybuses compared to those converted from buses. Both charts were based on data with minor differences as a result of changing the method of conducting the analyses in order to meet the required needs.

Table 5. Causes of failures of trolleybuses operated by PKT

Cause of failure		Rebuilt	Older than 10 years (old)	Between 2 and 10 years old	Newer than 2 years old (new)
outside and inside lighting + supply installation + steering	OS	55,20	73,75	57,85	30,85
door + steering	D	71,61	82,97	48,95	35,99
braking system + steering + supply	H	20,89	27,66	20,02	5,14
pollution	ZAN	4,48	0	2,22	0
pole ropes; ropewinders	LIN	23,87	46,09	22,25	18,85
steering of resistance starting system	URS	34,31	55,31	0	0
tyre; wheel	OG	4,48	9,22	4,45	3,43
starting, braking and auxiliary resistors	REZ	2,98	13,83	0	0
trolley pole; base	PAN	2,98	4,61	4,45	6,86
V – belts; belt pulleys	PAS	11,94	13,83	0	0
pneumatic suspension + ECAS + steering	POD	25,36	18,44	24,47	1,71
alternator + charging system	AL	5,97	4,61	0	0
traction or auxiliary engine	SIL	16,41	18,44	0	0
compressor	SP	2,98	0	4,45	3,43
information boards + installation + steering (of ticket puncher as well)	SIP	19,39	0	15,57	5,14
power electronic drive appliance	UNE	8,95	32,27	15,57	46,28
pneumatic system	UP	14,92	4,61	4,45	1,71
static converter	PS	1,49	55,31	13,35	5,14
wipers; mirrors	WYC	8,95	18,44	15,57	13,71
collector	ZB	38,79	50,70	53,4	20,57
entangled in network	ZS	1,49	27,66	6,67	3,43
ticket punchers + installation + steering	KAS	52,22	59,92	64,52	29,14
unknown	NIEZN	2,98	13,83	4,45	12,00
collision	KOL	8,95	23,05	17,8	10,28
other	INNE	8,95	4,61	8,90	1,71
electrical installation 600 V; JA + electrical connections	IWN	0	0	0	0
electrical installation 24 V + electrical connections	INN	5,97	13,83	2,22	0

electrical installation subassemblies – auxiliary system	IUP	0	4,61	8,90	3,43
remaining electrical subassemblies	ELEK	41,77	69,14	20,02	22,28
remaining mechanical subassemblies	MECH	13,43	9,22	2,22	0
contactor; switch	STY	14,92	18,44	2,22	0
metal plates; finish; inside equipment	BLA	22,38	4,61	28,92	6,86
freeze – up	ZAM	5,97	13,83	0	0

Source: Own work.

The data presented shows that the failure frequency of trolleybuses converted from buses is lower than in the oldest vehicles they replaced. It should be also noticed that their failure frequency is much higher than in new vehicles but it is comparable to those exploited for 2 to 10 years.

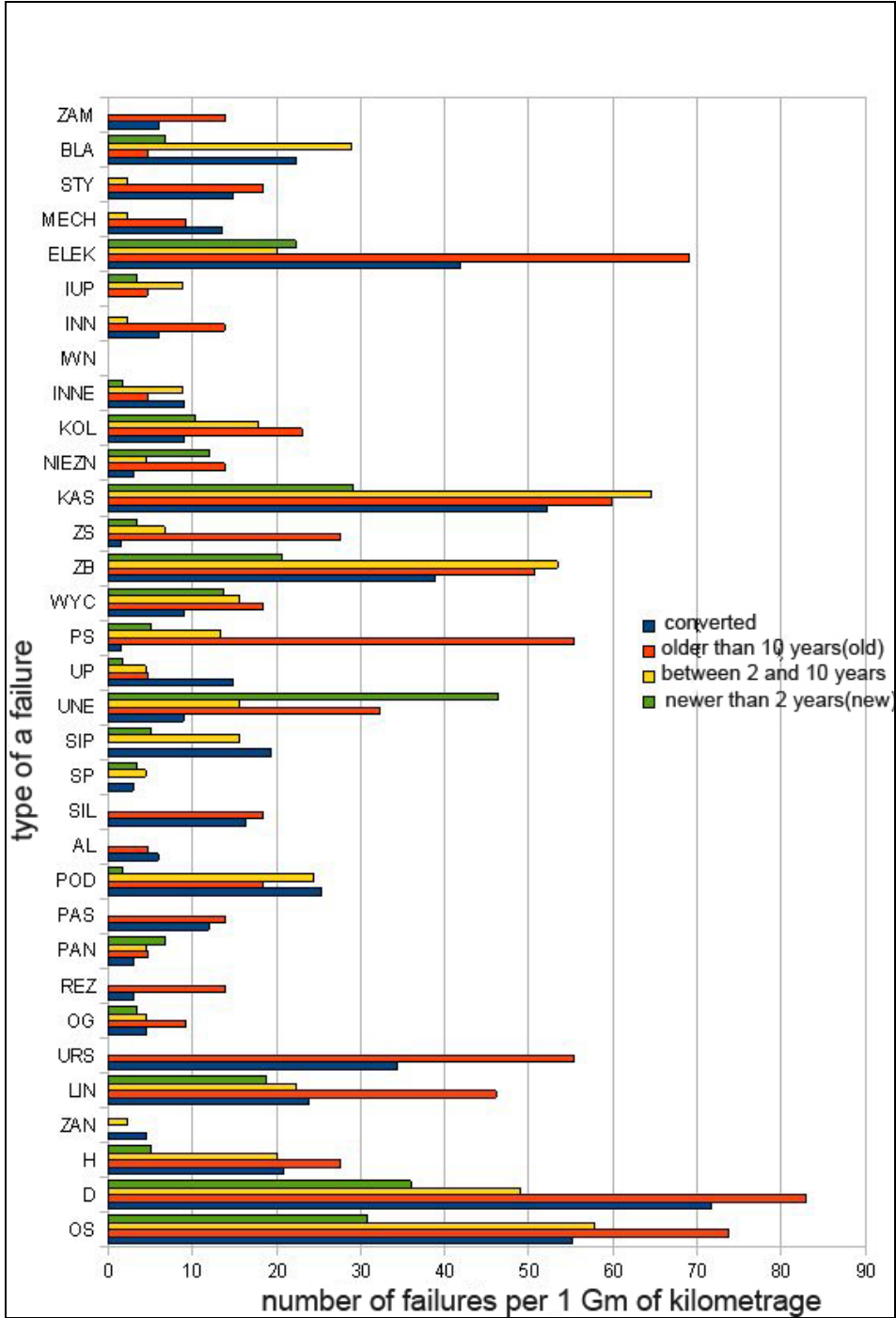

Fig. 4. Types of failures of trolleybuses operated by PKT

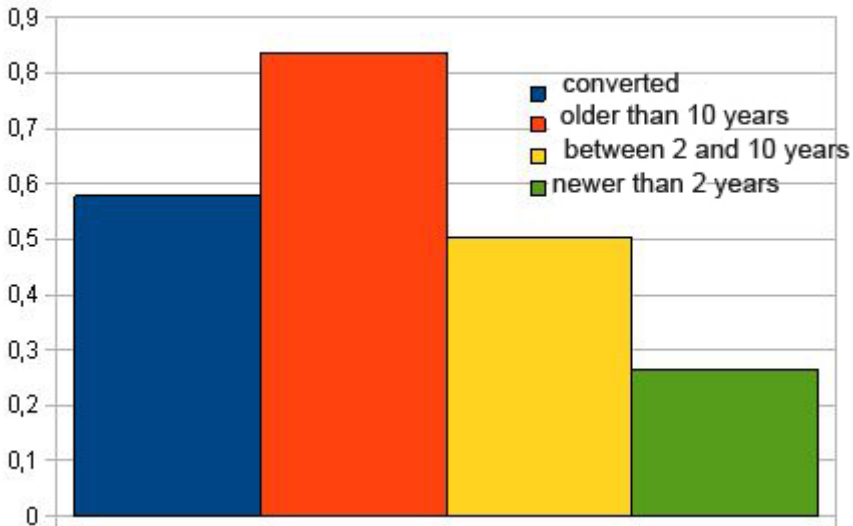

Fig. 5. Failure frequency of partial groups of trolleybuses operated by PKT

5.2. Exploitation experiments in Szeged

Before the company Szegedi Közlekedési Társaság introduced into exploitation Mercedes and Volvo trolleybuses converted from buses, they used high floor trolleybuses made in the USSR (ZiU 9), Czechoslovakia (Škoda 14Tr and 15Tr) and Hungary (Ikarus 280T). All aforementioned vehicles were designed in the 60s and 70s and they do not meet the requirements of modern public transport that is adjusted to meet the needs of all passengers, including disabled and elderly people. The high floor is only one of many drawbacks of old trolleybuses. The drives with obsolete structure which caused high electric energy consumption were used mainly in Soviet trolleybuses. ZiU i Ikarus vehicles were especially prone to corrosion as a result of their weak protection of tin coating and construction. All these features influenced the high failure frequency of the vehicles.

Compared to older trolleybuses, the new vehicles based on coachworks manufactured in the last few years, protected against corrosion and equipped with modern drive significantly improved exploitation indexes and lessened failure frequency indexes. Thanks to the introduction of low floor trolleybuses to everyday exploitation the company was able to begin regular, guaranteed service of particular transport tasks using vehicles adjusted to the needs of disabled people.

The previous exploitation of Volvo and Mercedes trolleybuses in Szeged presents the positive result obtained in the conversion of buses equipped with diesel engines into trolleybuses. The rich exploitation experiences collected since 2004 enabled the decision to be made to continue the replacement of trolleybus rolling stock with other vehicles made in one's own workshops. Bearing in mind that the coachwork of the Mercedes-Benz O530 is still in mass production and that O530 buses are favoured by numerous carriers all over the world, there is no reason to change the coachwork. The availability of these vehicles on the market is high and their price is not excessive. Moreover, the asynchronous drive applied can be regarded as one of the most modern used in urban electric traction. It is also in mass production and because of unification and lowering exploitation costs no change of drive supplier is planned.

The solution discussed by the authorities of the company from Szeged is using an auxiliary supply system in the form of a set of lithium ion batteries as the emergency drive system. As in Gdynia, it was decided that a trolleybus must remain a means of non emitting transport in the place of exploitation; therefore the only solution is batteries. In case of the company in Gdynia, the conventional solution in the form of nickel cadmium batteries was applied. These batteries are not very expensive but their huge kerb weight reduces the number of passenger seats. In the case of Szeged there is a possibility of applying the most modern lithium ion batteries, which have been so far applied serially only in electrical motor cars that are gradually introduced to public transport. The lithium ion batteries have small kerb weight and large water-hour capacity, which allows a trolleybus to cover long distances without supply from the contact system. The small kerb weight of batteries does not cause the significant reduction of passenger seats.

In the years 2004-2010 Szegedi Közlekedési Társaság company built 7 new trolleybuses on their own on the basis of coachwork of combustion buses Mercedes-Benz O530 i Volvo 7000. The results were low failure frequency and a positive reaction from passengers and that is why the idea of converting buses into trolleybuses has been continued. Before introducing to exploitation low floor trolleybuses built in their own workshops, the transport company in Szeged had not had any considerable experience in the sphere of modern drives and low floor trolleybuses. The trolleybuses fleet consisted mainly of worn-out Soviet trolleybuses ZiU 9, Czechoslovak trolleybuses Škoda 14Tr and 15Tr and Hungarian trolleybuses Ikarus 280T.

Supposedly, introducing modern low floor trolleybuses into exploitation significantly improved the image of trolleybus communication. It seems that the continuation of building trolleybuses according to this variant is not only an

economically efficient solution but also an exemplary one alternative to purchasing brand new trolleybuses at a time when the company faces financial shortages.

5.3. Analysis of strong and weak points of conversion

Like the majority of solutions applied, the conversion of buses into trolleybuses has its advantages and disadvantages. The importance of individual advantages and disadvantages is different depending on the conditions. In general, the profitability of converting buses into trolleybuses may be different for various reasons for different carriers.

PKT Gdynia's main reason for performing conversion is the necessity to modernise its rolling stock as well as the need to obtain low floor vehicles at a relatively low cost.

The main advantages of converting buses into trolleybuses are:

- low investment cost (2 to 5 converted trolleybuses instead of 1 brand new);
- obtaining low floor rolling stock;
- modernisation of the rolling stock (with minor reparations of a coachwork prognosticating longer exploitation than written off trolleybuses);
- greater choice of conversion method;
- possibility of in-house conversion (in depot conditions);

The main disadvantages of converting buses into trolleybuses are:

- 1) the result is a used vehicle with failure frequency as in old buses);
- 2) the unknown past of converted buses;
- 3) frequent provisional repairs of converted trolleybuses;
- 4) lack of technical documentation (sometimes only fragmentary or uncertain);
- 5) each vehicle of the same type is different (the differences are usually significant; therefore it is impossible to prepare universal documentation for conversion. It also requires a greater assortment of spare parts, causes difficulties with supply and results in a lack of service uniformity);

6

Economic evaluation of the process of conversion busses into trolleybusses by PKT in the years 2004-2010

6.1. The background of economic evaluation

In the years 2004-2010, 22 out of 28 converted vehicles were fitted with a recycled engine and steering system taken from the old vehicles. One vehicle converted in 2008 was equipped with a transitory solution, whilst 5 more recently converted vehicles were equipped with a fully innovative engine.

Considering different reasons for the conversion of the old buses into trolleybuses in the first and second stages, its economic efficiency should be determined for each stage with the exception of one vehicle which incorporated a transitory solution and as such shouldn't be deemed a reliable element of the assessed group.

6.2. Initial value of the converted and newly manufactured vehicles

Tables 6 and 7 illustrate the initial values of the converted vehicles and newly manufactured trolleybuses which were purchased at the same time.

The initial value of a converted trolleybus consists of the price of the purchased vehicle together with the cost of the conversion. If the vehicle was equipped with a combustion engine then the value obtained from the sale of such engine is deducted. The conversion cost includes the cost of purchase of spare parts and materials, labour, as well as the surcharge of overhead costs and equipment operating costs. The initial value of a new vehicle reflects its value before VAT tax. The economic efficiency of conversion can be calculated by comparing the initial value of the converted vehicles with the value of newly manufactured vehicles for each stage of the conversion, due to its different aims at both stages.

Table 6. The initial value of trolleybuses converted from the Mercedes buses by PKT in the years 2004–2010

Year	Vehicle Type	Date of Admittance o Service	Identification No	Price of Purchase [Polish Zloty]	Conversion Cost minus the Value of the Sale of the Combustion Engine [Polish Zloty]	Initial Value of the Vehicle [Polish Zloty]
2004	405NE	30.09.04	3046	130 000,00	153 570,67	283 570,67
	405NE	30.11.04	3048	166 000,00	99 874,62	265 874,62
2005	405NE	22.02.05	3055	150 000,00	87 430,19	237 430,19
	405NE	30.04.05	3063	150 000,00	109 652,64	259 652,64
	405NE	30.04.05	3059	150 000,00	109 507,35	253 507,35
	405NE	30.06.05	3056	150 000,00	104 163,68	254 163,68
	405NE	30.11.05	3061	150 000,00	142 853,42	292 853,42
	405NE	30.11.05	3061	150 000,00	142 853,42	292 853,42
2006	405NE	24.03.06	3065	155 000,00	130 195,39	285 195,39
	405NE	31.05.06	3064	140 000,00	126 140,60	266 140,60
	405NE	31.08.06	3050	165 000,00	127 040,99	292 040,99
	405NE	13.10.06	3066	155 000,00	140 120,34	285 120,34
	405NE	18.12.06	3051	165 000,00	141 371,78	306 371,78
2007	405NE	16.02.07	3057	210 000,00	138 750,20	348 750,20
	405NE	30.06.07	3045	155 000,00	153 176,64	308 176,64
	405NE	21.08.07	3047	155 000,00	154 145,69	309 145,69
	405NE	31.10.07	3062	155 000,00	160 215,73	315 215,73
	405NE	31.12.07	3041	155 000,00	167 716,84	322 716,84
2008	405NI	12.05.08	3052	250 000,00	307 669,31	557 669,31
	405NE	14.05.08	3013	220 000,00	170 445,56	390 445,56
	405NE	31.08.08	3015	170 000,00	183 465,43	353 465,43
	405NE	20.10.08	3014	200 000,00	141 526,59	341 526,59
	405NE	31.12.08	3016	200 000,00	217 216,61	417 216,61
2009	405NAC	14.12.09	3018	190 000,00	474 472,41	664 472,41
	405NE	02.12.09	3019	170 000,00	162 255,35	332 255,35
	405NAC	30.12.09	3020	180 000,00	364 331,74	544 331,74
2010	405NAC	31.03.10	3017	190 000,00	410 005,05	600 005,05
	405NAC	27.05.10	3058	180 000,00	296 571,68	476 571,68
	405NAC	30.07.10	3060	180 000,00	402 582,72	582 582,72

Source: data PKT.

Table 7. The initial value of the new Trollino vehicles purchased by PKT in the years 2004–2010

Year	Vehicle Type	Date of Admittance to Service	Identification No	Initial Value of the Vehicle [Polish Zloty]
2004	12AC	01.11.04	3003	1150000,00
2005	12AC	13.12.05	3030	1154800,00
	12AC	30.11.05	3032	1154800,00
	12AC	30.11.05	3028	1154800,00
2006	12AC	31.03.06	3036	1154800,00
	12AC	31.03.06	3039	1154800,00
	12AC	31.03.06	3033	1154800,00
	12AC	30.04.06	3081	1154800,00
	12AC	30.04.06	3082	1154800,00
	12AC	30.04.06	3083	1154800,00
	12AC	30.04.06	3084	1154800,00
	12AC	30.05.06	3085	1154800,00
	12AC	31.12.06	3005	1154800,00
2007	12ACIII	24.12.07	3009	1116303,00
2008	12ACIII	18.04.08	3011	1188989,00
2009	–	–	–	–
2010	12M	31.01.10	3012	1494600,00
	12M	31.01.10	3010	1494600,00
	12M	11.10.10	3006	1589000,00
	12M	11.10.10	3007	1589000,00
	12M	11.10.10	3008	1589000,00
	12M	11.10.10	3023	1589000,00
	12M	11.10.10	3024	1589000,00
	12M	11.10.10	3025	1589000,00
	12M	20.10.10	3026	1589000,00
	12M	20.10.10	3027	1589000,00
	12M	20.10.10	3029	1589000,00
	12M	20.10.10	3031	1589000,00
	12M	19.11.10	3034	1589000,00
	12M	19.11.10	3035	1589000,00
	12M	19.11.10	3067	1589000,00
	12M	19.11.10	3068	1589000,00
2011	12M	20.01.11	3070	1589000,00
	12M	20.01.11	3071	1589000,00

12M	20.01.11	3072	1589000,00
12M	20.01.11	3073	1589000,00
12M	04.11.11	3074	1589000,00
12M	04.11.11	3075	1589000,00
12M	04.11.11	3076	1589000,00
12M	04.11.11	3077	1589000,00
12M	04.11.11	3078	1589000,00
12M	04.11.11	3079	1589000,00

Source: data.PKT.

In the first years of conversion 5 vehicles were converted annually, excluding the first and the last years. The value of a converted vehicle was between 130 and 220 thousand Polish Zloty. The difference was determined mostly by the year and the model of the vehicle. Second generation Mercedes O405 N, which was given the inventory numbers 3057, 3019, and from 3013 to 3016 were more expensive being as they were newer and more functional (some seats were placed directly on the floor). The conversion costs were also variable and at this stage amounted from 87 to 217 thousand Polish Zloty. They depended mostly on the technical and exploitation condition of the converted bus which also determined the time and extent of modernisation. Consequently, the initial value of a vehicle in the first stage amounted to between 237 and 417 thousand Polish Zloty with 316 thousand being the average.

At the second stage of conversion the value of the bus was between 180 – 190 thousand Polish Zloty, thus it varied slightly. Large variations occurred in the cost of conversion of the buses which amounted to between 297 and 474 thousand Polish Zloty, depending largely on the extent of the work required and duration of a conversion. The initial value of a trolley at the 2nd stage increased from 476 to 664 thousand Polish Zloty, 574 thousands Polish Zloty being the average.

The cost of brand new Solaris Urbino 12 vehicles between the years 2004-2009, would be from 1,150 thousand to 1,589 thousand Polish Zloty. The most expensive vehicles belong to the purchase made and partially funded from the EU Regional Development Fund. The price was the result of a high standard of technical equipment which included AC, electrically controlled pantographs, as well as a backup battery drive of a substantial range.

6.3. Duration of the conversion of the vehicles

Table 8 presents the duration of the conversion of particular vehicles. This was an important factor which influenced the conversion cost.

Table 8. Duration of conversion of particular vehicles by PKT

Identification No	Duration of the Conversion
3052	app. 6 months
3018	8 months
3017	app. 5 months
3060	4 months
Other	app.3 months

Source: data PKT.

The time devoted to a conversion of particular vehicles was varied (see Table 8) and lasted between 3 to 8 months. In the case of 24 vehicles the smallest time frame was required. The longest conversion (8 months) was the conversion of the first vehicle at the second stage. It was a pioneered conversion which included the implementation of a new electric equipment. The long duration of its conversion resulted in its higher price.

6.4. The relation of the initial value of the converted and brand new vehicles as a criterion for the economic evaluation of the process

Tables 9 and 10 present the relations and differences of the initial value of converted and brand new vehicles characteristic of the first and second stages respectively.

The relation between the values of two types of vehicles was taken as a criterion for the evaluation of the effectiveness of the conversion. It was based on the assumption that the PKT was aiming to rapidly increase the number of low floor trolleybuses in their fleet, yet at the same time did not have any particular means allocated to carry out such change.

It follows from the data presented in Table 9 that the relation between the price of a converted and brand new vehicle in the years 2004-2009, using the old

engines was located at the lowest and highest levels of 25% and 35% respectively. The average relation for 22 vehicles amounted to 26% which means that at this stage, on average 4 converted vehicles were introduced for every brand new trolleybus. The functional effect of the more rapid introduction of low floor buses was achieved.

Table 9. The relation and differences between the values of the converted vehicles and the brand new trolleybuses at the first stage of the conversion in PKT (2004–2009)

Year	Identification No of a Converted Vehicle	Initial Value of a Converted Vehicle [Polish Zloty]	Identification No of a Brand New Vehicle Purchased that Same year	Initial Value of a Brand New Vehicle [Polish Zloty]	Relation between the Values of a Converted and Brand New Vehicles [%]	Difference Between the Values of a Brand New and Converted Vehicle [Polish Zloty]
2004	3046	283 570,67	3003	1 150 000,00	24,66	866 429,33
2004	3048	265 874,62	3003	1 150 000,00	23,12	884 125,38
2005	3055	237 430,19	3030	1 154 800,00	20,56	917 369,81
2005	3063	259 652,64	3030	1 154 800,00	22,48	895 147,36
2005	3059	253 507,35	3030	1 154 800,00	21,95	901 292,65
2005	3056	254 163,68	3030	1 154 800,00	22,01	900 636,32
2005	3061	292 853,42	3030	1 154 800,00	25,36	861 946,58
2006	3065	285 195,39	3036	1 154 800,00	24,70	869 604,61
2006	3064	266 140,60	3036	1 154 800,00	23,05	888 659,40
2006	3050	292 040,99	3036	1 154 800,00	25,29	862 759,01
2006	3066	285 120,34	3036	1 154 800,00	24,69	869 679,66
2006	3051	306 371,78	3036	1 154 800,00	26,53	848 428,22
2007	3057	348 750,20	3009	1 116 303,00	31,24	767 552,80
2007	3045	308 176,64	3009	1 116 303,00	27,61	808 126,36
2007	3047	309 145,69	3009	1 116 303,00	27,69	807 157,31
2007	3062	315 215,73	3009	1 116 303,00	28,24	801 087,27
2007	3041	322 716,84	3009	1 116 303,00	28,91	793 586,16
2008	3013	390 445,56	3011	1 188 989,00	32,84	798 543,44
2008	3015	353 465,43	3011	1 188 989,00	29,73	835 523,57
2008	3014	341 526,59	3011	1 188 989,00	28,72	847 462,41
2008	3016	417 216,61	3011	1 188 989,00	35,09	771 772,39
2009	3019	332 255,35	3010	1 494 600,00	22,23	1 162 344,65
Total	–	6 720 836,31	–	25 680 071,00	26,17	18 959 234,69
Average	–	305 492,56	–	1 167 275,95	–	861 783,40

Source: data PKT.

Table 10. The relation and differences between the values of the converted vehicles and the brand new trolleybuses on the second stage of the conversion in PKT(2009–2010)

Year	Identification No of a Converted Vehicle	Initial Value of a Converted Vehicle [Polish Zloty]	Identification No of a Brand New Vehicle Purchased that Same year	Initial Value of a Brand New Vehicle [Polish Zloty]	Relation between the Values of a Converted and Brand New Vehicles [%]	Difference Between the Values of a Brand New and Converted Vehicle [Polish Zloty]
2009	3018	664 472,41	3010	1 494 600,00	44,46%	830 127,59
2009	3020	544 331,74	3010	1 494 600,00	36,42%	950 268,26
2010	3017	600 005,05	3006	1 589 000,00	37,76%	988 994,95
2010	3058	476 571,68	3006	1 589 000,00	29,99%	1 112 428,32
2010	3060	582 582,72	3006	1 589 000,00	36,66%	1 006 417,28
Total	–	2 867 963,60	–	7 756 200,00	36,98%	4 888 236,40
Average	–	573 592,72	–	1 551 240,00	–	977 647,28

Source: data PKT.4

It follows from the data presented in Table 10 that the relation between the cost of a converted and brand new vehicle in the years 2004-2009, using the new power plants was located on the lowest and highest levels of 30% and 44% respectively. An average relation for 5 converted vehicles at the time amounted to 37% which means that on average 3 converted vehicles were introduced for every one brand new trolleybus on this stage. The functional effect of a quicker introduction of low floor trolleybuses together with an additional exploitation and economic effect of a smoother drive and a lower power consumption were achieved.

6.5. Conclusion on economic evaluation

To sum up, the procedure of conversion of a used bus into a trolleybus in PKT, can be perceived as being economically efficient. Due to the conversion the process of exchange of an old fleet for new low floor vehicles was substantially quickened. Particular exploitation and economic effects were also achieved.

Towards the end of the year 2011 the make-up of the fleet was dominated by low floor trolleybuses which constituted 89% of the entire fleet of this operator. 37% of these vehicles were obtained by means of conversion, which means that more than one in 3 vehicles was previously a low floor bus. The vast majority of the brand new vehicles within the PKT fleet are a result of the company's

participation in two EU projects. As part of the project 35 vehicles were purchased and partially funded by the EU. This, in turn, means that only 13 low floor vehicles were obtained through means other than that of a conversion or an EU project. This fact strengthens the impression that the conversion of vehicles was the crucial factor in achieving the change of the public's perception of the trolleybuses. This was achieved over a period of time similar to that required for a total exchange of the fleet.

The positive perception of the conversion of used vehicles, in both technical and economic respects, resulted in the decision of PKT to continue process. In 2011 the third stage of conversion began with a modern Mercedes O530 Citaro bus being converted into a trolleybus. This vehicle is equipped with AC which distinguishes it from the other converted vehicles. It also possesses a stronger backup drive which allows it to travel more kilometres without the network. As part of the third stage of the conversion a new project involving a second Mercedes O530 Citaro vehicle was taken on.

Summary

Before commencing the project of building trolleybuses based on the coachwork of buses from the aftermarket PKT had only 7 low floor buses including 1 Jelcz trolleybus M121MT from 1999 and 6 trolleybuses Solaris Trollino 12 in two types of drive. The remaining 70 vehicles were trolleybuses Jelcz PR110E and 120MTE. They were significantly worn-out and characterized by a high index of failure frequency. Introducing into exploitation a new type of vehicle based on the unknown and partially worn German coachwork evoked the fear of maintaining the high index of failure frequency. The exploitation experience proved, however, that those fears were exaggerated and the failure frequency of the mechanical parts of ten to twelve years old trolleybuses is lower than in case of high floor Jelcz trolleybuses. The coachwork are characterised by high durability and a properly protected construction and metal plates are not prone to corrosion. In the rolling stock fleet trolleybuses MB O405N have higher failure frequency in terms of their transport work than new Solaris Trollino trolleybuses, but it is significantly lower than in old Jelcz trolleybuses.

Failure frequency indexes of particular types of trolleybuses exploited in PKT in Gdynia are as follows:

- Solaris: 0,2-0,3 failure per 1 thousand kilometers,
- Mercedes: 0,3-0,5 failure in the summer and 0,8-1,0 in the winter per 1 thousand kilometers,
- Jelcz: 0,7-0,9 failure in the summer and over 1,0 in the winter per 1 thousand kilometers.

The conclusion drawn from the data presented is that introducing trolleybuses MB O405N2 into exploitation improved the exploitation indexes, not to mention the benefits provided by the low floor and interior comfort of the vehicle.

According to the primary assumptions of converting buses into trolleybuses the in-house made trolleybuses were to be exploited for 6-7 years. These assumptions were verified by the lack of possibility to buy a greater number of brand new vehicles. The present assumption is that trolleybuses MB O405N will be exploited for 10 years. Their good technical state and relatively low failure frequency enables such an assumption to be made.

The project of converting buses into trolleybuses is an original solution to the problem of obtaining a significant number of low floor trolleybuses on a low budget in order to address the disproportion that appeared between trolleybus and bus transportation in Gdynia. The idea of building trolleybuses based on coachwork of buses coming from the aftermarket instead of performing the major repairs of high floor Jelcz trolleybuses appears to have been successful in both a social and economical sphere. The result of the idea that had its beginning in 2003 was 28 newly converted trolleybuses MB O405N out of 85 owned by PKT in Gdynia (as at March 2011), which is about one third of the whole rolling stock fleet.

The primary cost of building a trolleybus was comparable to the cost of major renovation of a Jelcz vehicle. However, as a result of purchasing and installing new energy efficient drives, it turned out to be about 37% of a brand new trolleybus. The conversion intensified the pace of replacing old trolleybuses which were negatively assessed by passengers. Thanks to introducing Mercedes vehicles into exploitation Gdynia obtained a high percentage of vehicles adapted to the needs of people with mobility impairments in a relatively short time and with a small financial outlay. The new trolleybuses significantly influenced the passengers' opinion of trolleybus transportation and improved the company exploitation indexes. Very good exploitation experiences encourage the ongoing in-house building of trolleybuses as a supplement to the purchasing of brand new trolleybuses and the spreading of the idea among all trolleybus operators who need to modernise their vehicle fleet but lack the required funds to purchase brand new trolleybuses.

Bibliography

- [1] Połom M. (2005), *Pierwszy na świecie trolejbus Mercedes-Benz O405N*, Zajezdnia, nr 1(6), p. 6-7.
- [2] Połom M., Bartłomiejczyk M. (2010), *Eksploatacja i rozwój infrastruktury oraz taboru przedsiębiorstwa komunikacji trolejbusowej w Gdyni*, Technika Transportu Szynowego, no. 7-8, p. 18–21.
- [3] Połom M., Palmowski T. (2009), *Rozwój i funkcjonowanie komunikacji trolejbusowej w Gdyni*, Wydawnictwo Bernardinum, Pelplin, p. 152.
- [5] Połom M., Bartłomiejczyk M. (2011), *Konwersja autobusów niskopodłogowych na trolejbusy w Gdyni*, Autobusy – Technika, Eksploatacja, Systemy Transportowe, p. 14–19.

Strony internetowe:

- [1] www.pktgdynia.pl
- [2] www.trolejbusy.strefa.pl

List of tables

1. Number of converted trolleybuses operated by PKT according to their type of drive	10
2. List of elements of electrical instalation used while converting the first Mercedes trolleybus by PKT	28
3. Failure frequency indexes of trolleybuses operated by PKT	49
4. Failure frequency of particular types of trolleybuses operated by PKT	49
5. Causes of failures of trolleybuses operated by PKT	52
6. The initial value of trolleybuses converted from the Mercedes buses by PKT in the years 2004–2010	59
7. The initial value of the new Trollino vehicles purchased by PKT in the years 2004–2010	60
8. Duration of conversion of particular vehicles by PKT	62
9. The relation and differences between the values of the converted vehicles and the brand new trolleybuses at the first stage of the conversion in PKT (2004–2009)	63
10. The relation and differences between the values of the converted vehicles and the brand new trolleybuses on the second stage of the conversion in PKT (2009–2010)	64

List of figures

1. An example of the schedule of conversion of a bus into a trolleybus	15
2. The number of failures of trolleybuses operated by PKT	51
3. Failure frequency indexes of trolleybuses operated by PKT	51
4. Types of failures of trolleybuses operated by PKT	54
5. Failure frequency of partical groups of trolleybuses operated by PKT	55
6. Machinery arrangement in trolleybus O405N equipped with contactor drive	72
7. Electrical drive machinery arrangement in combustion engine compartment of trolleybus O405N equipped with contactor drive	73
8. Scheme of main circuits of trolleybus O405N equipped with contactor drive	74
9. Machinery arrangement in trolleybus O405N equipped with impulse (chopper) drive	75

10. Electrical drive machinery arrangement in combustion engine compartment of trolleybus O405N equipped with impulse (chopper) drive	75
11. Scheme of main circuits of trolleybus O405N equipped with impulse (chopper) drive	76
12. Machinery arrangement in trolleybus O405N equipped with impulse (chopper) drive	77
13. Electrical drive machinery arrangement in combustion engine compartment of O405N trolleybus equipped with impulse (chopper) drive	77
14. Scheme of main circuits of trolleybus O405N equipped with asynchronous drive	78
15. Machinery arrangement in O530 trolleybus equipped with asynchronous drive (Szeged)	79
16. Electrical drive machinery arrangement in combustion engine compartment of O530 trolleybus equipped with asynchronous drive (Szeged)	79
17. Machinery arrangement in trolleybus O530 equipped with asynchronous drive (Gdynia)	80
18. Main circuits scheme of trolleybus O530 equipped with asynchronous drive (Gdynia)	81
19. Scheme of method of trolleybuses insulation realisation	82

SUPPLEMENT

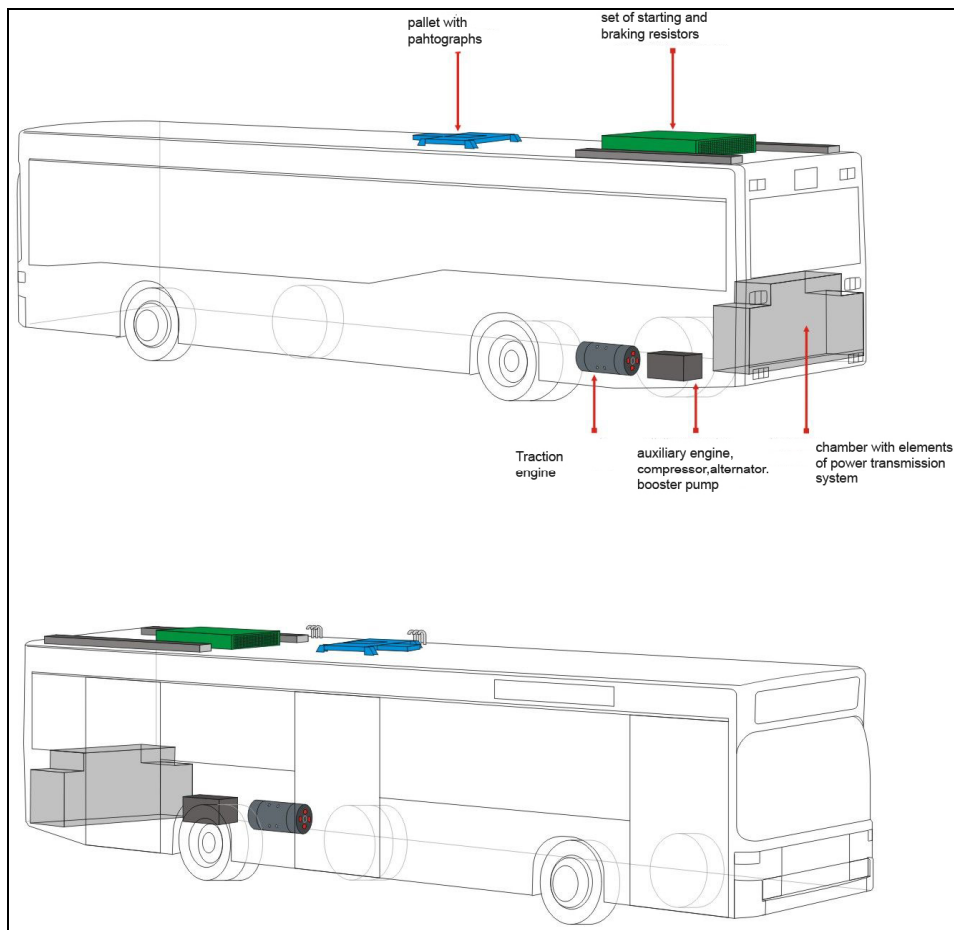

Fig. 6. Machinery arrangement in trolleybus O405N equipped with contactor drive
(Authors: Maciej Beister, Marcin Polom)

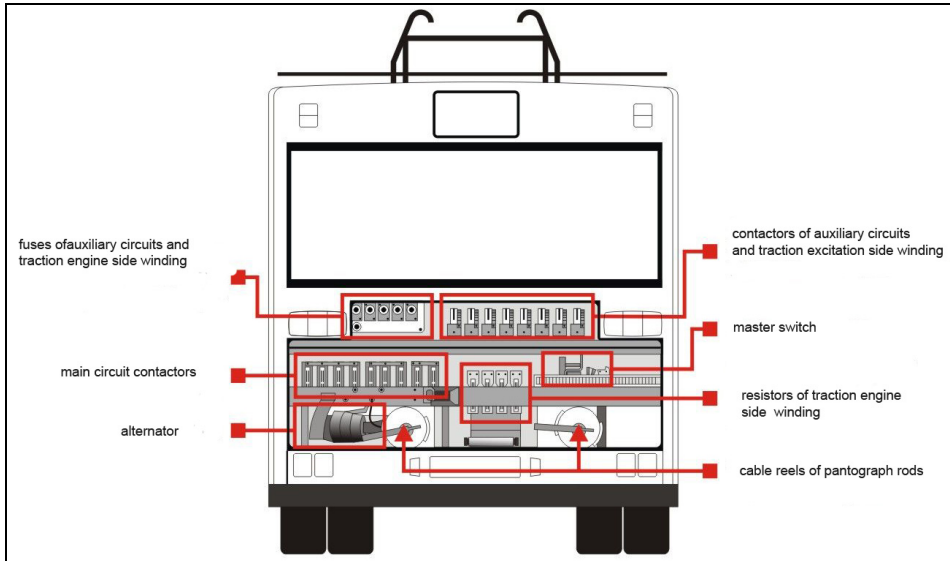

Fig. 7. Electrical drive machinery arrangement in combustion engine compartment of trolleybus O405N equipped with contactor drive (Authors: Maciej Beister, Marcin Polom)

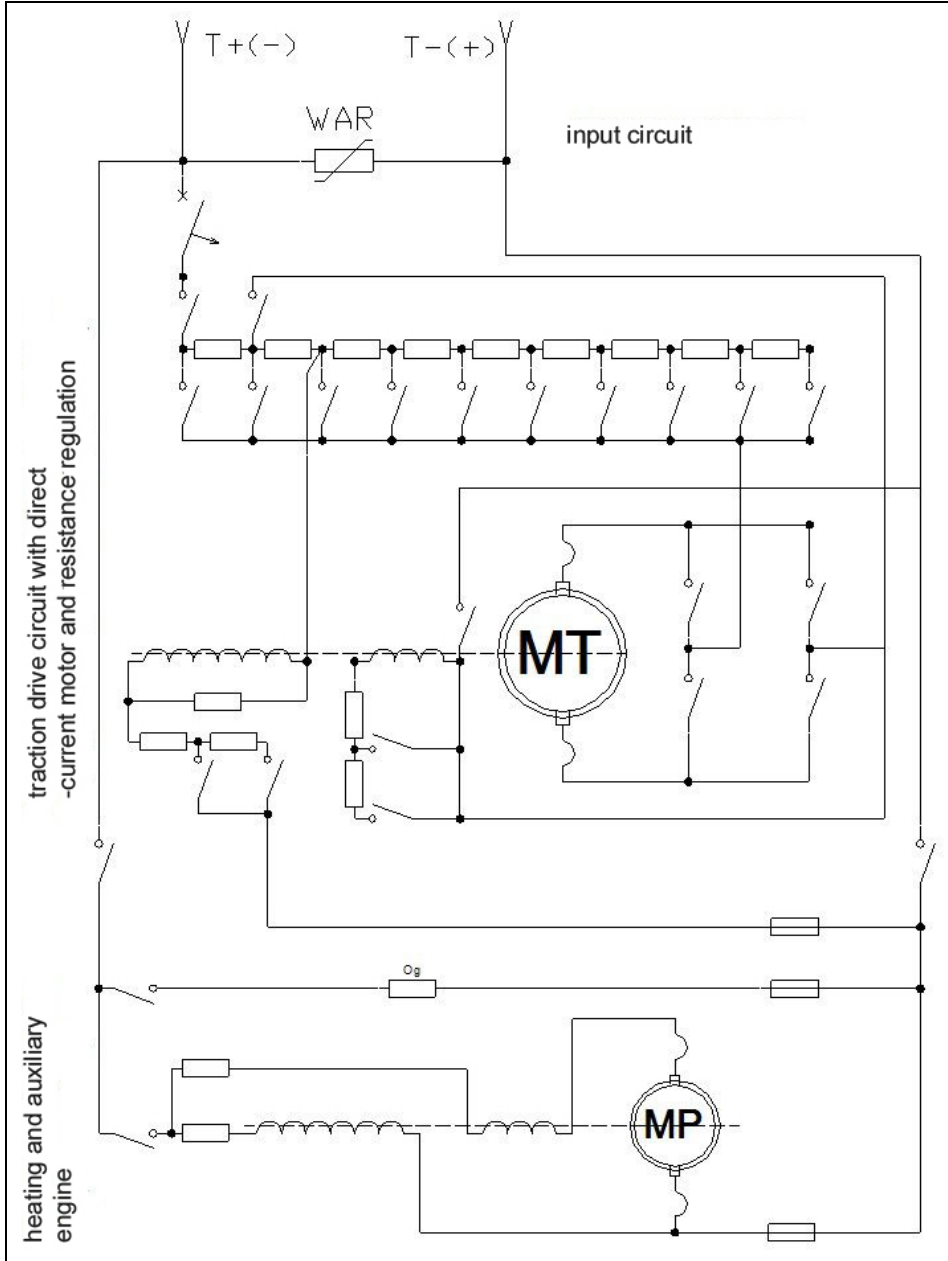

Fig. 8. Scheme of main circuits of trolleybus O405N equipped with contactor drive
(Author: Jarosław Dombrowski)

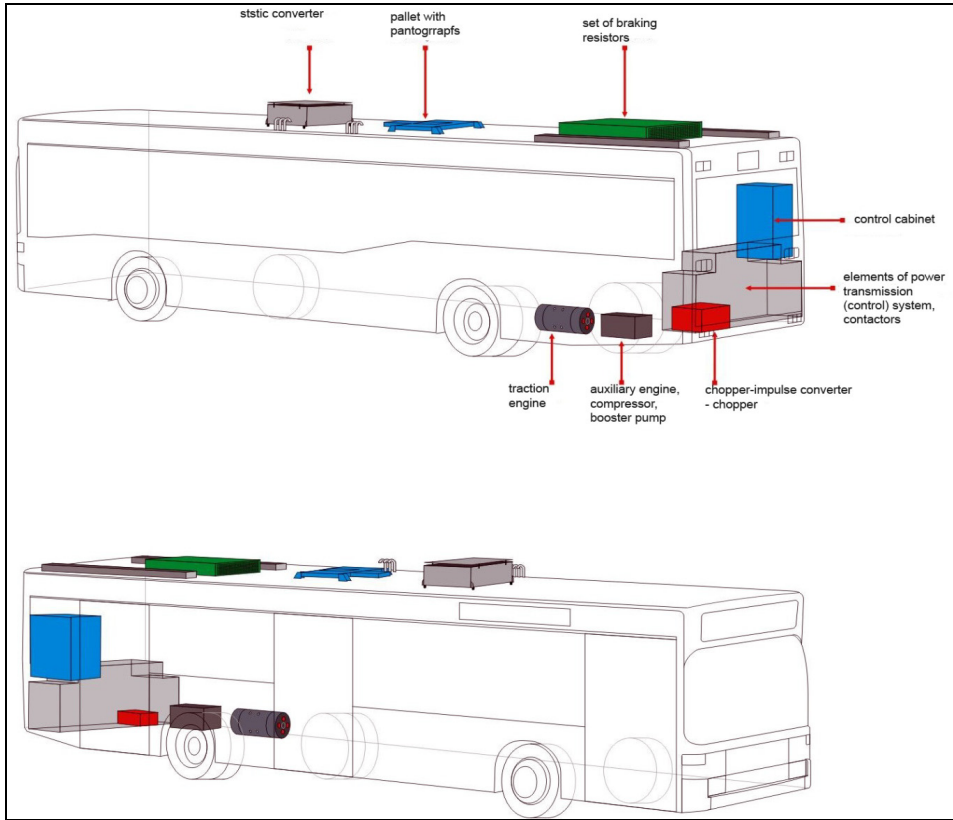

Fig. 9. Machinery arrangement in trolleybus O405N equipped with impulse (chopper) drive
(Authors: Maciej Beister, Marcin Polom)

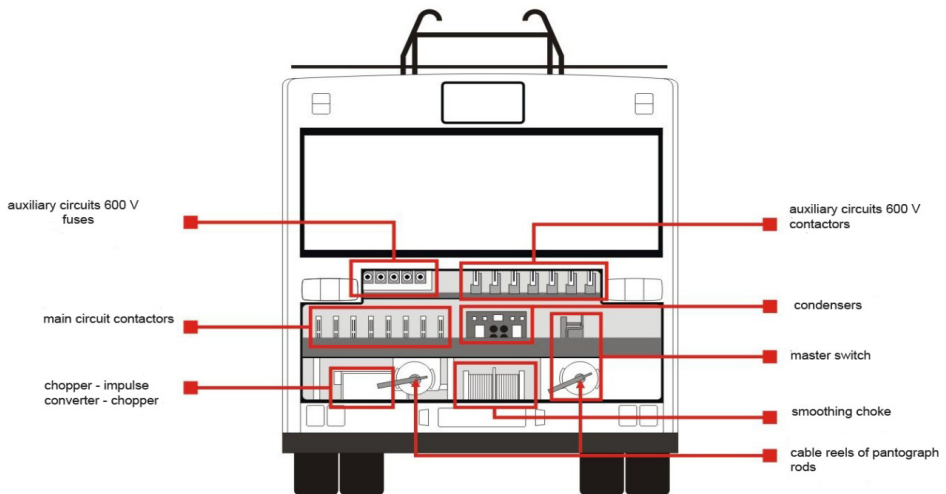

Fig. 10. Electrical drive machinery arrangement in combustion engine compartment of trolleybus O405N equipped with impulse (chopper) drive (Authors: Maciej Beister, Marcin Polom)

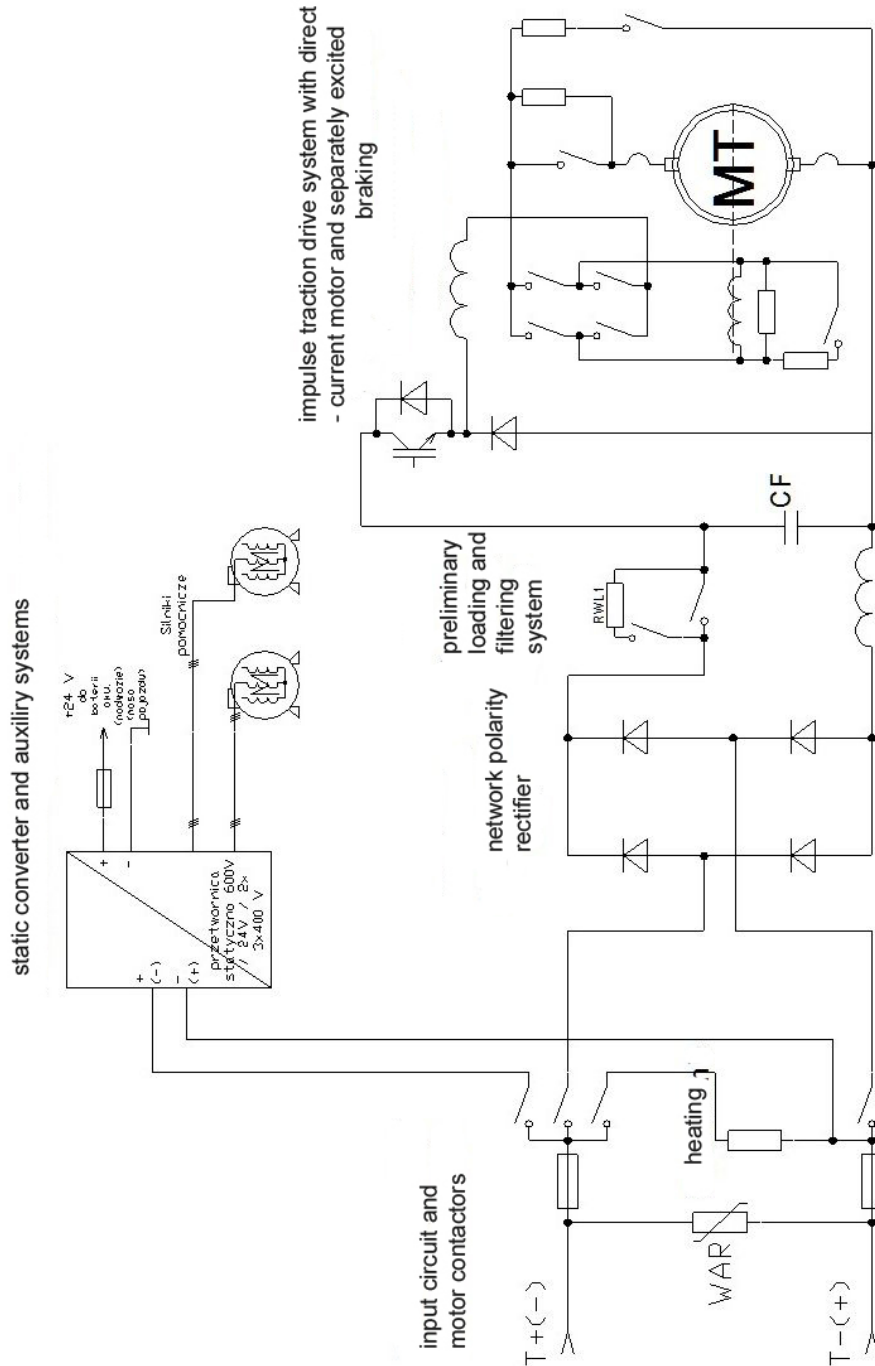

Fig. 11. Scheme of main circuits of trolleybus O405N equipped with impulse (chopper) drive
(Author: Jarosław Dombrowski)

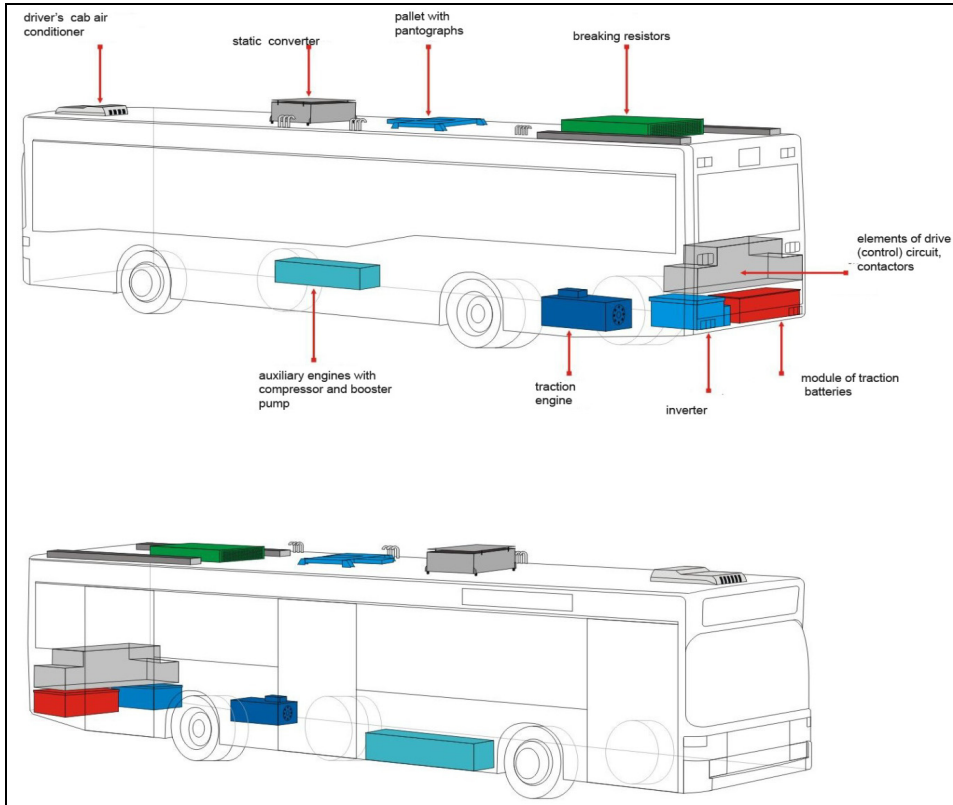

Fig. 12. Machinery arrangement in trolleybus O405N equipped with impulse (chopper) drive (Authors: Maciej Beister, Marcin Potom)

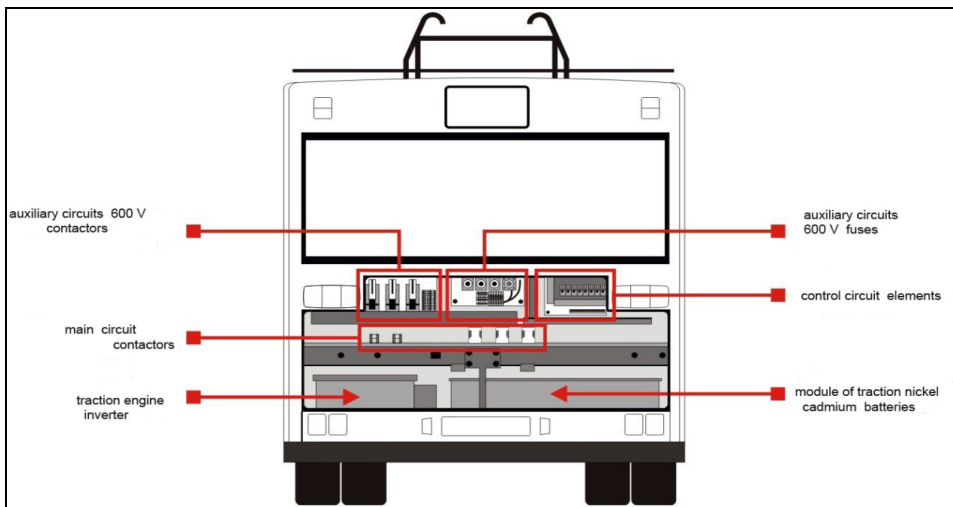

Fig. 13. Electrical drive machinery arrangement in combustion engine compartment of O405N trolleybus equipped with impulse (chopper) drive (Authors: Maciej Beister, Marcin Potom)

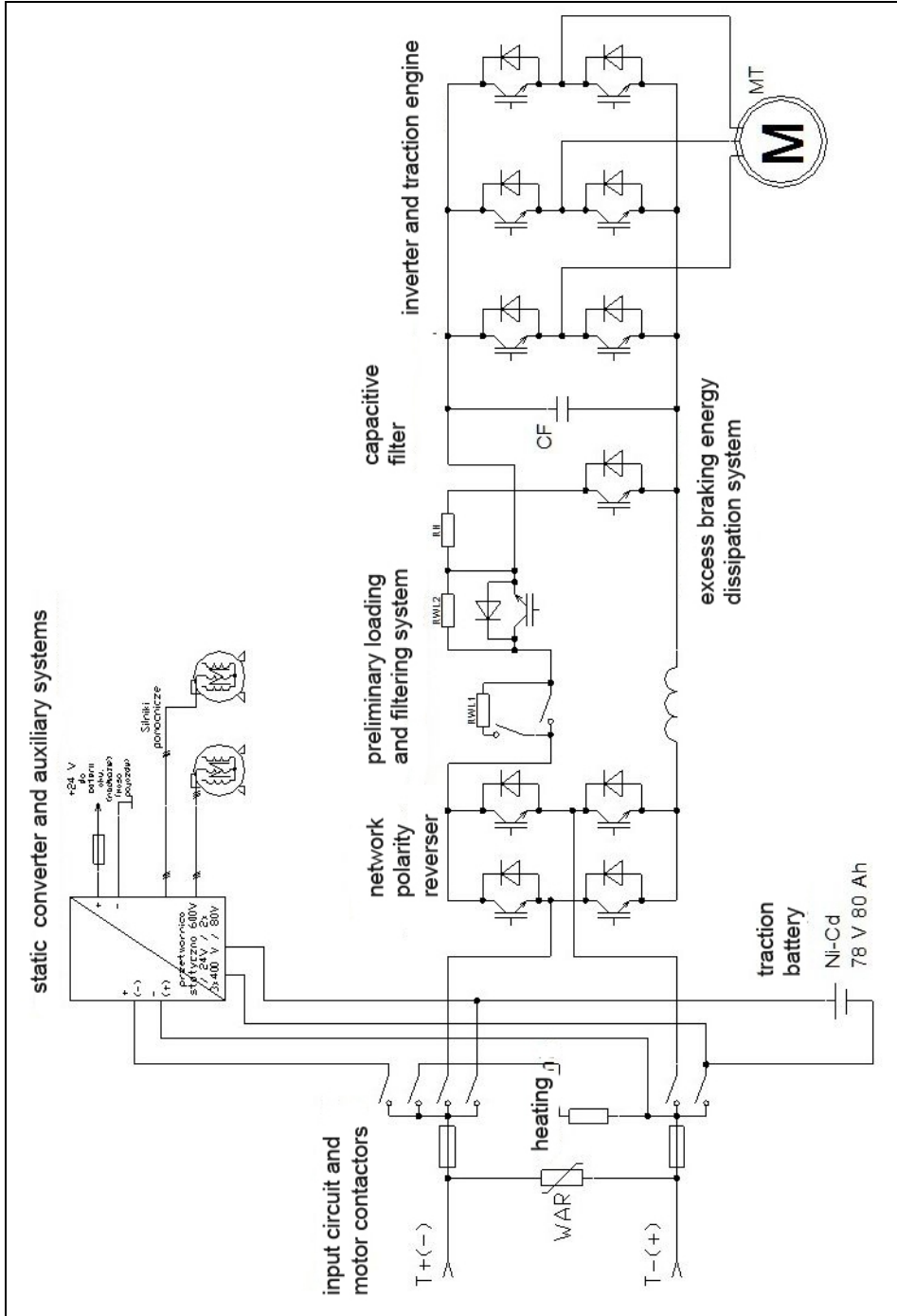

Fig. 14. Scheme of main circuits of trolleybus O405N equipped with asynchronous drive
(Author: Jarosław Dombrowski)

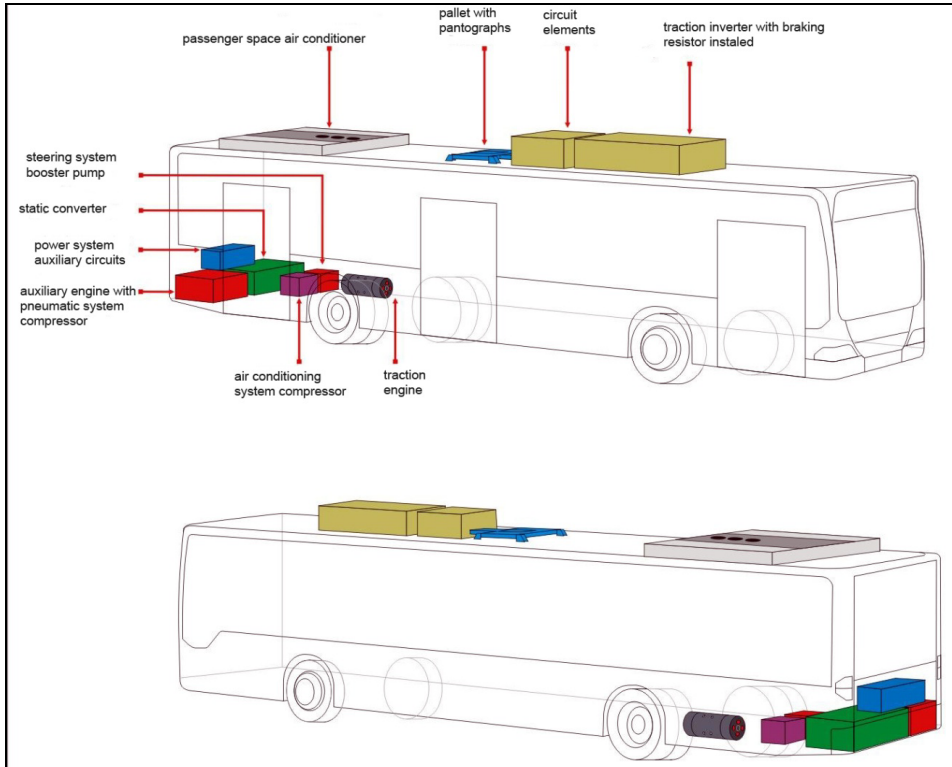

Fig. 15. Machinery arrangement in O530 trolleybus equipped with asynchronous drive (Szeged) (Authors: Maciej Beister, Marcin Polom)

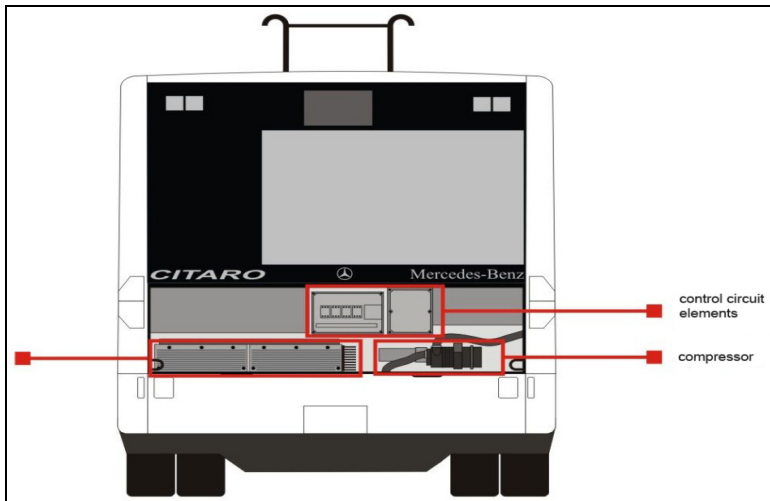

Fig. 16. Electrical drive machinery arrangement in combustion engine compartment of O530 trolleybus equipped with asynchronous drive (Szeged) (Authors: Maciej Beister, Marcin Polom)

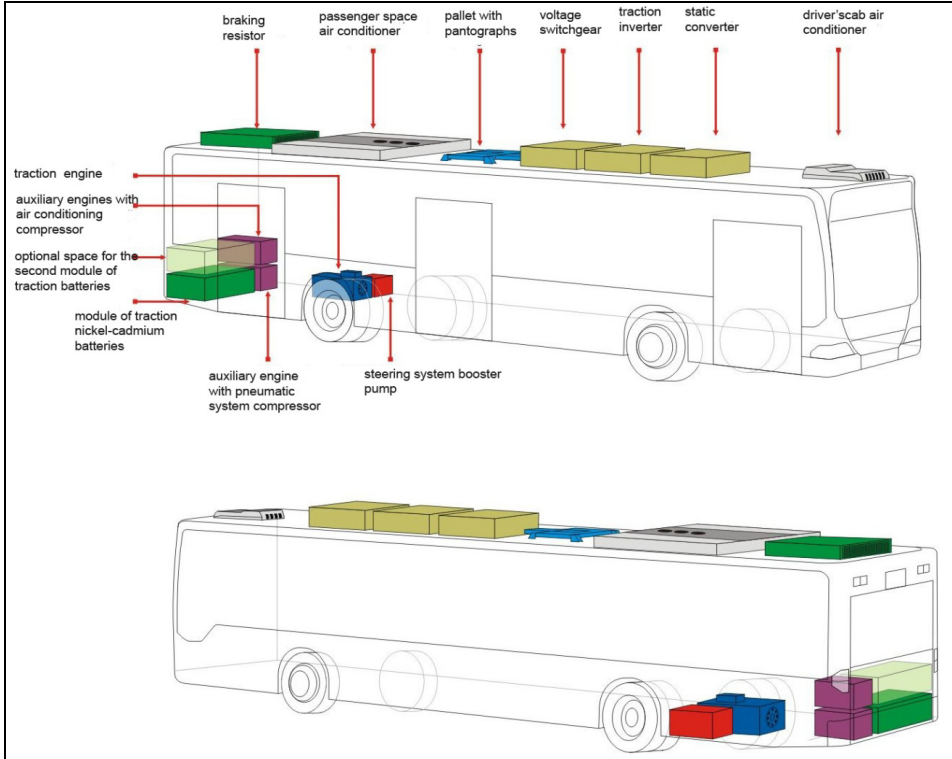

Fig. 17. Machinery arrangement in trolleybus O530 equipped with asynchronous drive (Gdynia)
(Authors: Maciej Beister, Marcin Połom)

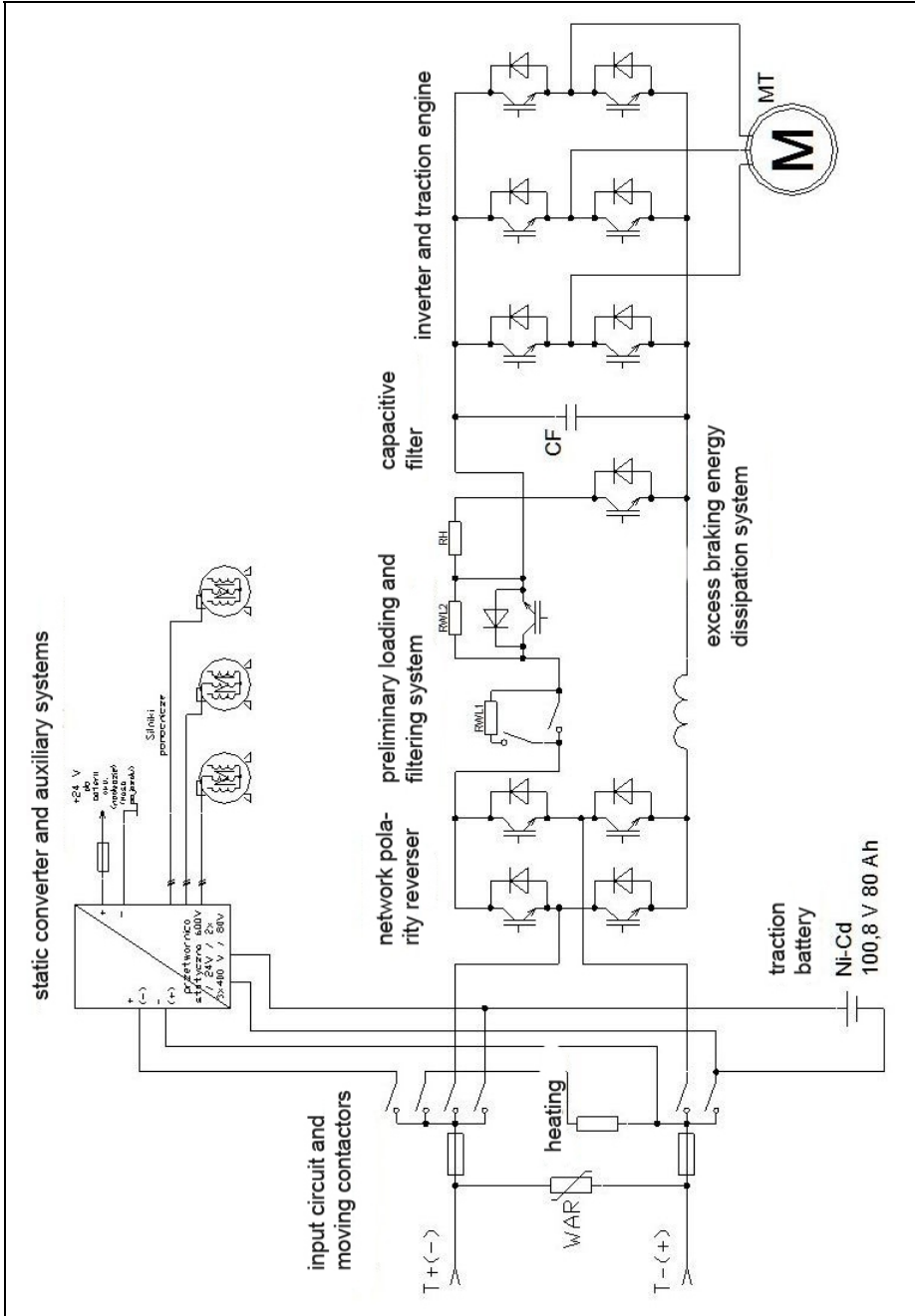

Fig. 18. Main circuits scheme of trolleybus O530 equipped with asynchronous drive (Gdynia)

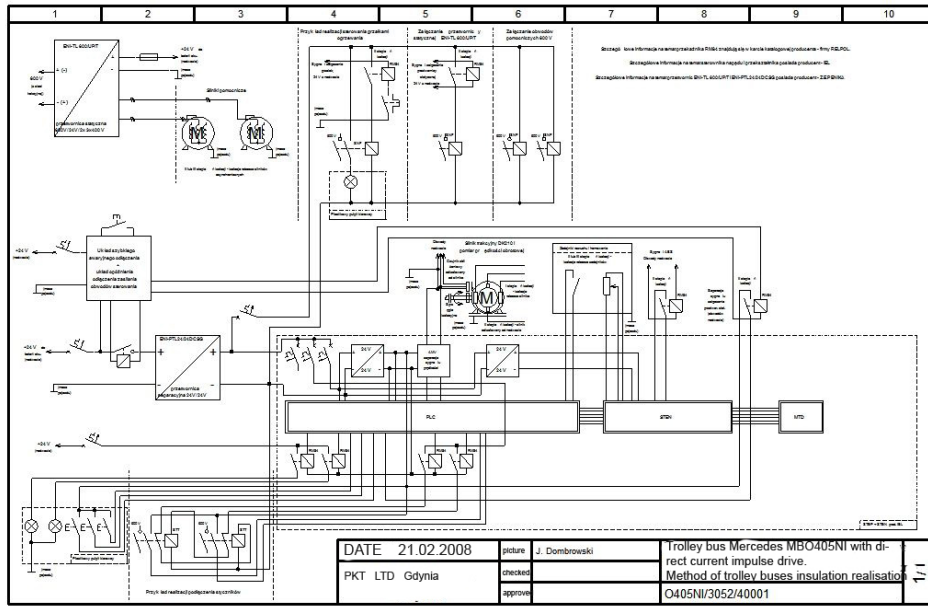

Fig. 19. Scheme of method of trolleybuses insulation realisation